

Pallet truck scale [KERN VHB\(SK\)](#)



Transportation and weighing, with a memory for a container weight

Features

- **PRE-TARE function** for manual subtraction of a known container weight, e. g. pallet cages, pallets etc., which can't be saved
- **1 Display device IP65.** Protected against dust and water splashes
- **2 Load fork IP67.** Load cells are protected against dust and water, temporary use in wet areas is possible
- **Pivot range 206°**
- **Castors:** Solid rubber on aluminium rims
- **3 Load rollers:** Tandem tyres so that you can get over thresholds and obstacles more easily. Material: Polyurethane
- **Ready for use:** Batteries included 4 x 1.5 V AA. AUTO-OFF function to preserve the batteries. Operating time up to 80 h / up to 1700 weighings

Technical data

- Large LCD display, digit height 28 mm

Accessories

- **Castors made of red polyurethane on aluminium rims.** Ideal for light-coloured flooring as they leave less visible marks. Suitable for the current models of the pallet truck scale ranges KERN VHB, KERN VHS (when retrofitting, please give the serial number of the pallet truck scale available when ordering), KERN VHB-A02

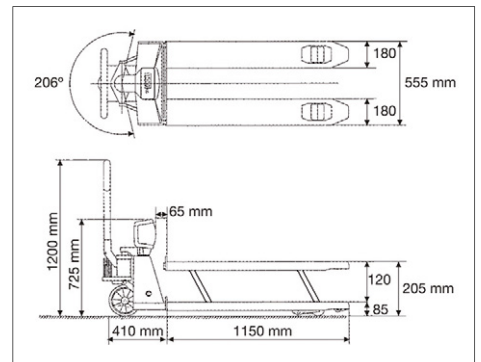

Note: As standard, the unit is dispatched without the shaft and display fitted. The shaft and display can be fitted at our factory for an additional cost, delivery + 2 working days, KERN VFS-M01
Please state when ordering

! Shipment via freight forwarder. Please ask for dimensions, gross weight, shipping costs

STANDARD





































OPTION



Model	Weighing range [Max] kg	Readout [d] kg	Net weight approx. kg	Permissible ambient temperature °C	Option DKD Calibr. Certificate	
					DKD KERN	
KERN VHB 2T1	2000	1	120	-10 °C / 40 °C	963-131	

KERN Pictograms

 Internal adjusting (CAL): Quick setting of the balance's accuracy with internal adjusting weight (motordriven).	 Recipe level A: Separate memory for the weight of the tare container and the recipe ingredients (net total).	 Rechargeable battery pack: rechargeable set.
 Adjusting program (CAL): For quick setting of the balance's accuracy. External adjusting weight required.	 Recipe level B: Internal memory for complete recipes with name and target value of the recipe ingredients. User guidance through displays.	 Mains adapter: 230V/50Hz in standard version for Germany. On request GB, AUS or USA version.
 Memory: Balance contains memories, e.g. for item data, weighing data, tare weights etc. PLU.	 Recipe level C: Internal memory for complete recipes with name and target value of the recipe ingredients. User guidance through displays. Additional convenient functions, such as barcode and back calculation functions.	 Power supply: integrated in balance. 230V/50Hz in Germany. More standards e. g. GB, AUS, USA on request.
 Data interface RS-232: To connect the balance to a printer, PC or network.		 Strain gauges: Electrical resistor on an elastic deforming body.
 RS 485 data interface: To connect the balance to a printer, PC or other peripheral devices. High tolerance against electromagnetic disturbance.	 Percentage determination: Determining the deviation in % from the target value (100%).	 Tuning fork principle: A resonating body is electromagnetically excited, causing it to oscillate.
 USB data interface: To connect the balance to a printer, PC or other peripheral devices.	 Weighing units: Can be switched to e. g. non-metric units at the touch of a key. See balance model. Please refer to KERN's website for more details.	 Electromagnetic force compensation: Coil in a permanent magnet. For the most accurate weighings.
 Bluetooth data interface: To transfer data from the balance to a printer, PC or other peripheral devices.	 Weighing with tolerance range: Upper and lower limiting can be programmed individually, e.g. dosing/sorting and portioning.	 Single cell technology: Advanced version of the force compensation principle with the highest level of precision.
 Control outputs (optocoupler, digital I/O): to connect relays, signal lamps, valves, etc.	 Vibration-free weighing: (Animal weighing program) Vibrations are filtered out so that a stable weight is obtained.	 Verification possible: The time required for verification is specified in the pictogram.
 Interface for second balance: for direct connection of a second balance.	 Spray and dust protection IPxx: The type of protection is shown by the pictogram. For details see the glossary.	 DKD calibration possible: The time required for DKD calibration is shown in days in the pictogram.
 Network interface: For connecting the scale to an Ethernet network. With KERN products you can also use a universal RS-232/LAN converter.	 Stainless steel: the balance is protected against corrosion.	 Package shipment: The time required to manufacture the product internally is shown in days in the pictogram.
 GLP/ISO record keeping: of weighing data with date, time and identification-no. Only with printers from KERN.	 Suspended weighing: load support with hook on the underside of the balance.	 Pallet shipment: The time required to manufacture the product internally is shown in days in the pictogram.
 Piece counting: Reference quantities selectable. Display can be switched from piece to weight.	 Battery operation: Ready for battery operation. The battery type is specified for each device.	 Warranty: The warranty period is shown in the pictogram.

Precision is our business

To ensure the high precision of your balance KERN offers you the the appropriate test weight package for your balance, consisting of the test weight, box and DKD certificate, as proof of ist accuracy ... the best pre-requisite for proper balance calibration.

In the extensive KERN test weight range, you will find test weights in the international OIML error limit classes: E1, E2, F1, F2, M1, M2, M3 with weights from 1 mg - 2000 kg.

The KERN DKD calibration laboratory for electronic balances and weights has been accredited by DKD since 1994 and today is one of the most modern and best-equipped DKD calibration laboratories for balances, test weights and force-measurement in Europe.

(DKD = German Calibration Service)

Thanks to the high level of automation, we can carry out DKD calibration of balances, test weights and force-measuring devices 24 hours a day, 7 days a week.

Range of services:

- DKD calibration of balances with a maximum load of up to 6 t
- DKD calibration of weights in the range of 1 mg – 500 kg
- Database supported management of checking equipment and reminder service
- Calibration of force-measuring devices
- DKD calibration certificates in the following languages
D, GB, F, I, E, NL, PL

Do you have questions about your scale, the corresponding test weight or the calibration service? Your KERN specialist dealer will be pleased to assist you.

Your KERN specialist dealer: