

Návod na obsluhu(EN) Obchodná váha s výpočtom ceny

KERN RPB D(SK)

Version 2.4
04/2013
GB





KERN RPB_D

Version 2.4 04/2013

Instruction Manual

Price computing scales

Contents

1	Technical data	4
1.1	Dimensions	5
2	Appliance overview	6
2.1	Overview of display.....	7
2.2	Keyboard overview	9
3	Basic Information (General)	10
3.1	Proper use	10
3.2	Improper Use	10
3.3	Warranty	10
3.4	Monitoring of Test Resources.....	10
4	Basic Safety Precautions	11
4.1	Pay attention to the instructions in the Operation Manual	11
4.2	Personnel training.....	11
5	Transport and storage	11
5.1	Testing upon acceptance	11
5.2	Packaging / return transport	11
6	Unpacking, Setup and Commissioning	12
6.1	Installation Site, Location of Use	12
6.2	Unpacking.....	12
6.3	Transport screw.....	13
6.3.1	Placing.....	13
6.3.2	Scope of delivery / serial accessories:.....	14
6.4	Mains connection.....	14
6.5	Battery power supply (option)	14
6.6	Initial Commissioning.....	14
6.7	Adjustment.....	15
6.8	Verification	17
6.8.1	Adjustment controls and seals.....	18
6.9	Checking the balance verification settings	18
6.9.1	Service mode.....	19
7	Operation Mode	22
7.1	Turn on/off	22
7.2	Zeroing.....	22
7.3	Weighing with taring	22
7.4	Overload warning.....	22
8	Weighing with price determination	23
8.1	Basic price entry via keyboard	23
8.1.1	Unit switch over €/kg to €/100 g.....	24
8.2	Memory for basic price (PLU = Price look up)	26
9	Additional useful functions	28
9.1	AUTO CLEAR.....	28
9.2	Display background illumination	28
9.3	AUTO POWER OFF	29

10	Service, maintenance, disposal.....	30
10.1	Cleaning.....	30
10.2	Service, maintenance	30
10.3	Disposal.....	30
11	Instant help.....	31
11.1	Error messages	31
12	Declaration of -Conformity.....	32

1 Technical data

Models without vertical display:

KERN	RPB 6K1DM	RPB 15K2DM	RPB 30K5DM
Weighing range (max)	3 kg / 6 kg	6 kg / 15 kg	15 kg / 30 kg
Readability (d)	1 g / 2 g	2 g / 5 g	5 g / 10 g
Minimum load (Min)	20 g	40 g	100 g
Verification value (e)	1 g	2 g	5 g
Verification class	III	III	III
Reproducibility	1 g / 2 g	2 g / 5 g	5 g / 10 g
Linearity	± 1 g / ±2 g	± 2 g / ± 5 g	± 5 g / ±10 g
Recommended adjusting weight (not supplied)	6 kg (F2)	15 kg (M1)	30 kg (M1)
Stabilization time	2 s		
Heating time (operating temperature)	10 min		
Net weight (kg)	3.8 kg		
Basic price, can be switched over	€/kg; €/100 g		
Admissible ambient temperature	-10° C to 40° C		
Allowable air humidity	0 % - 80 % (non-condensing)		
Electric Supply	Mains adapter 220 V – 240 V AC 50 Hz balance 12 V, 500 mA		
Rechargeable battery (Option)	6 V, 4 Ah		
	Operating time – background lighting on 40 hrs. Operating time – background lighting off 80 hrs.		
	Loading time approx. 12 hrs.		

Models with post-mounted display:

KERN	RPB 6K1DHM	RPB 15K2DHM	RPB 30K5DHM
Weighing range (max)	3 kg / 6 kg	6 kg / 15 kg	15 kg / 30 kg
Readability (d)	1 g / 2 g	2 g / 5 g	5 g / 10 g
Minimum load (Min)	20 g	40 g	100 g
Verification value (e)	1 g	2 g	5 g
Verification class	III	III	III
Reproducibility	1 g//2 g	2 g//5 g	5 g//10 g
Linearity	± 1 g / ±2 g	± 2 g / ± 5 g	± 5 g / ±10 g
Recommended adjusting weight (not supplied)	6 kg (F2)	15 kg (M1)	30 kg (M1)
Stabilization time	2 s		
Heating time (operating temperature)	10 min		
Net weight (kg)	4.8 kg		
Basic price, can be switched over	€/kg; €/100 g		
Admissible ambient temperature	-10° C to 40° C		
Allowable air humidity	0 % - 80 % (non-condensing)		
Electric Supply	Mains adapter 220 V – 240 V AC 50 Hz balance 12 V, 500 mA		
Rechargeable battery (Option)	6 V, 4 Ah		
	Operating time – background lighting on 40 hrs. Operating time – background lighting off 80 hrs.		
	Loading time approx. 12 hrs.		

1.1 Dimensions

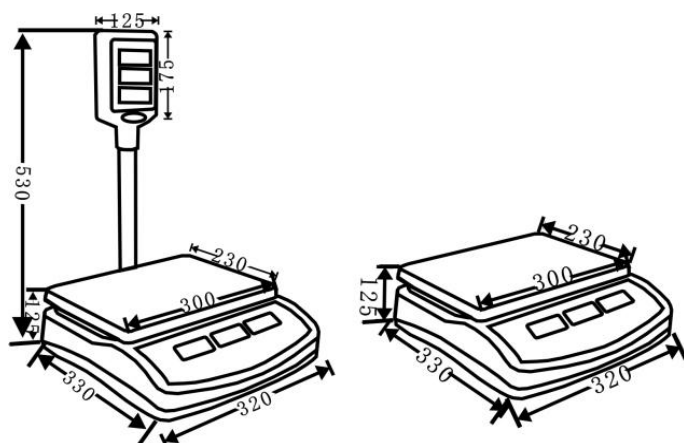

2 Appliance overview

Models without vertical display:



Models with post-mounted display:

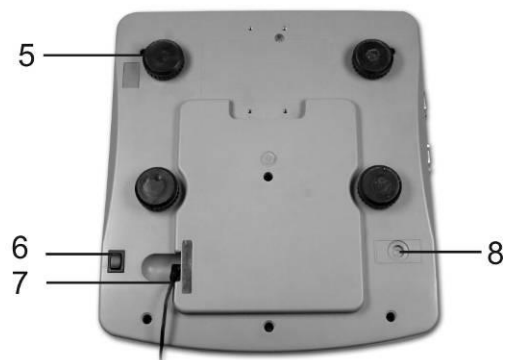
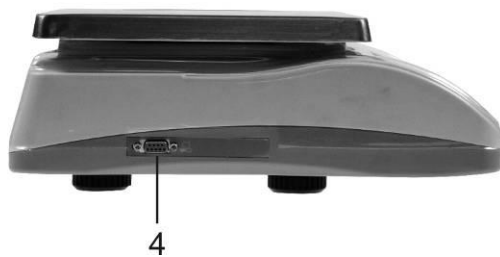

1. Weighing plate / rechargeable battery compartment (under weighing plate)
2. Bubble level
3. Post-mounted display
4. Not documented
5. Foot screws
6. ON/OFF switch
7. Mains adapter connection
8. Adjustment switch

2.1 Overview of display

Operator and secondary display (standard on the backside of models without post-mounted display):

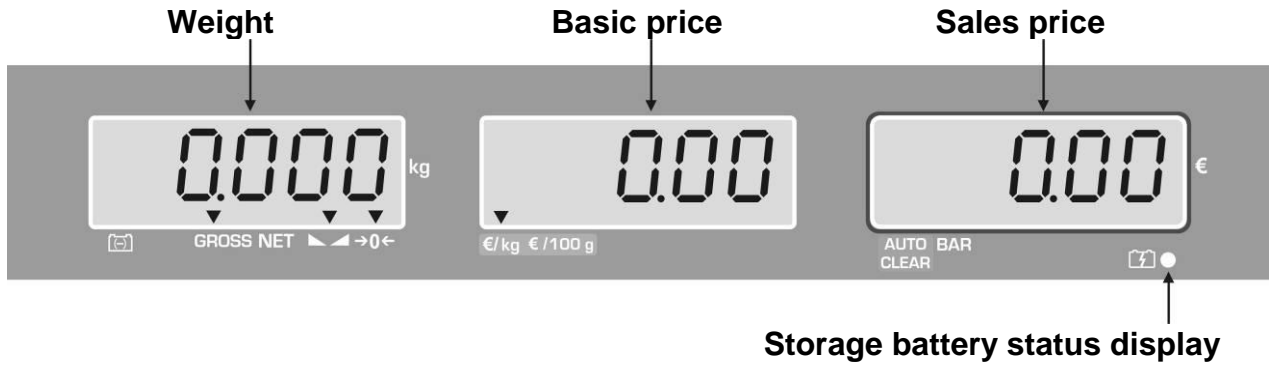

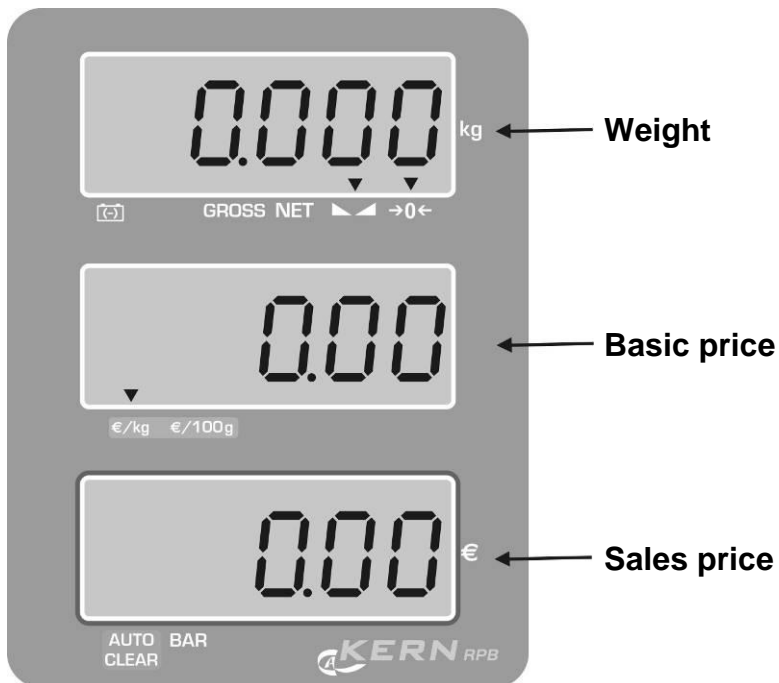

Post-mounted display for models with tripod:



Display weight

Here, the weight of your goods is displayed.

Indicator ▼ next to symbol displays:

	Battery very low
GROSS	Gross weight
NET	Net weight
	Stability display
→0←	Zeroing display

Display basic price

Basic price, can be switched over from € / kg or € / 100 g.

Indicator ▼ next to symbol displays:

€/kg	Basic price in €/kg
€/100 g	Basic price in €/100 g

Display sale price

Here the sales price is displayed in Euro [€].

Indicator ▼ next to symbol displays:

AUTO CLEAR	Set basic price is deleted automatically when balance is unloaded
BAR	Calculating the change (see chap. 8.2)







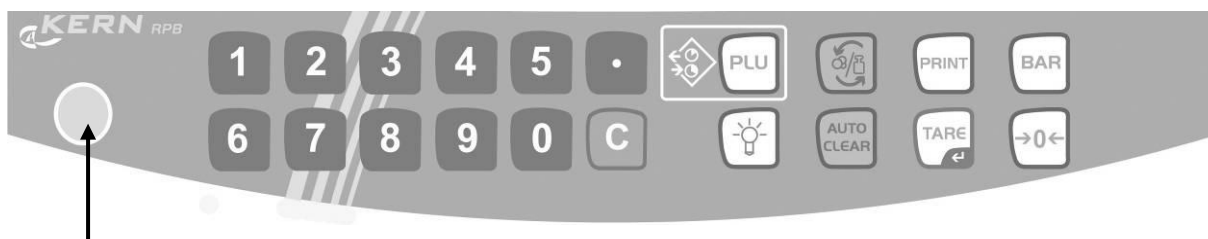





Storage battery status display

red	Charging storage battery
green	Battery is completely discharged

2.2 Keyboard overview



Bubble level

Selection	Function
 ~ 	3 Numerical keys, PLU-keys
	<ul style="list-style-type: none"> Delete
 	<ul style="list-style-type: none"> Save basic price (press and hold key for a long time) see chap. 8.2 Call-up basic price (press and hold key for a short time), see chap. 8.2
	<ul style="list-style-type: none"> Switch-over unit € / kg ↔ € / 100g
	<ul style="list-style-type: none"> Issue to external device Parameter selection
	<ul style="list-style-type: none"> Calculating the change, see chap. 8.2
	<ul style="list-style-type: none"> Taring, see chap. 7.3 Storing settings
	<ul style="list-style-type: none"> Background illumination of the display, see chap. 9.2
	<ul style="list-style-type: none"> If function is activated, the set basic price is automatically deleted when the balance is unloaded, see chap. 9.1
	<ul style="list-style-type: none"> Zeroing Back to weighing mode

3 Basic Information (General)

3.1 Proper use

The balance you purchased is intended to determine the weighing value of material to be weighed. It is intended to be used as a “non-automatic balance”, i.e. the material to be weighed is manually and carefully placed in the centre of the weighing plate. As soon as a stable weighing value is reached the weighing value can be read.

3.2 Improper Use

Do not use balance for dynamic weighings. In the event that small quantities are removed or added to the material to be weighed, incorrect weighing results can be displayed due to the “stability compensation“. (Example: Slowly draining fluids from a container on the balance.) Do not leave permanent load on the weighing plate. This may damage the measuring system.

Impacts and overloading exceeding the stated maximum load (max) of the balance, minus a possibly existing tare load, must be strictly avoided. Balance may be damaged by this.

Never operate balance in explosive environment. The serial version is not explosion protected.

The structure of the balance may not be modified. This may lead to incorrect weighing results, safety-related faults and destruction of the balance.

The balance may only be used according to the described conditions. Other areas of use must be released by KERN in writing.

3.3 Warranty

Warranty claims shall be voided in case

- Our conditions in the operation manual are ignored
- The appliance is used outside the described uses
- The appliance is modified or opened
- Mechanical damage or damage by media, liquids, natural wear and tear
- The appliance is improperly set up or incorrectly electrically connected
- The measuring system is overloaded

3.4 Monitoring of Test Resources

In the framework of quality assurance the measuring-related properties of the balance and, if applicable, the testing weight, must be checked regularly. The responsible user must define a suitable interval as well as type and scope of this test. Information is available on KERN's home page (www.kern-sohn.com) with regard to the monitoring of balance test substances and the test weights required for this. In KERN's accredited DKD calibration laboratory test weights and balances may be calibrated (return to the national standard) fast and at moderate cost.

4 Basic Safety Precautions

4.1 Pay attention to the instructions in the Operation Manual



Carefully read this operation manual before setup and commissioning, even if you are already familiar with KERN balances.

Versions in other languages are non-binding translations.
The only binding version is the original document in German.

4.2 Personnel training

The appliance may only be operated and maintained by trained personnel.

5 Transport and storage

5.1 Testing upon acceptance

When receiving the appliance, please check packaging immediately, and the appliance itself when unpacking for possible visible damage.

5.2 Packaging / return transport



- ⇒ Keep all parts of the original packaging for a possibly required return.
- ⇒ Only use original packaging for returning.
- ⇒ Prior to dispatch disconnect all cables and remove loose/mobile parts.
- ⇒ Reattach possibly supplied transport securing devices.
- ⇒ Secure all parts such as the glass wind screen, the weighing platform, power unit etc. against shifting and damage.

6 Unpacking, Setup and Commissioning

6.1 Installation Site, Location of Use

The balances are designed in a way that reliable weighing results are achieved in common conditions of use.

You will work accurately and fast, if you select the right location for your balance.

Therefore, observe the following for the installation site:

- Place the balance on a firm, level surface;
- Avoid extreme heat as well as temperature fluctuation caused by installing next to a radiator or in the direct sunlight;
- Protect the balance against direct draughts due to open windows and doors;
- Avoid jarring during weighing;
- Protect the balance against high humidity, vapours and dust;
- Do not expose the device to extreme dampness for longer periods of time. Non-permitted condensation (condensation of air humidity on the appliance) may occur if a cold appliance is taken to a considerably warmer environment. In this case, acclimatize the disconnected appliance for ca. 2 hours at room temperature.
- Avoid static charge of goods to be weighed or weighing container.

If electro-magnetic fields or static charge occur, or if the power supply is unstable major deviations on the display (incorrect weighing results) are possible. In that case, the location must be changed.

6.2 Unpacking

Carefully remove the balance from the packaging, remove plastic cover and setup balance at the intended workstation.

6.3 Transport screw



Remove the transport screw essential
(available only at 6 kg model)



To loosen the transportation lock, unscrew transportation screw [1] anti-clockwise.

For transport, transport screw gently until it stops turning clockwise and then secure with lock nut.

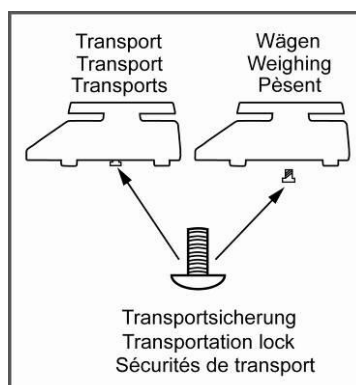

6.3.1 Placing

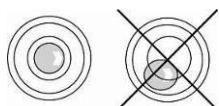

Level balance with foot screws until the air bubble of the water balance is in the prescribed circle.

6.3.2 Scope of delivery / serial accessories:

- Balance, see chap. 2
- Mains adapter
- Protective cover
- Instruction Manual

6.4 Mains connection

Power is supplied via the external mains adapter. The stated voltage value must be the same as the local voltage.

Only use KERN original mains adapter. Using other makes requires consent by KERN.

6.5 Battery power supply (option)

The rechargeable battery is charged via the delivered power supply.

Before the first use, the battery should be charged by connecting it to the mains power supply for at least 15 hours.

- If an arrow appears on the weight display [▼] above the battery symbol , this is an indication that the capacity of the rechargeable battery will soon be exhausted. The balance will be ready to operate for about another 10 hours, then it will switch off automatically. Charge the battery with the help of the supplied power pack.
- If in the weight display appears „bat Lo“ followed by a flickering display, the capacity of the rechargeable battery is below the prescribed minimum. The balance will be ready to operate for about another 5 minutes, then it will switch off automatically. Charge the battery with the help of the supplied power pack.

The LED display informs you during loading about the loading status of the rechargeable battery.

red: Battery is almost discharged

green: Battery is completely discharged

6.6 Initial Commissioning

In order to obtain exact results with the electronic balances, your balance must have reached the operating temperature (see warming up time chap. During this warming up time the balance must be connected to the power supply (mains, accumulator or battery).

The accuracy of the balance depends on the local acceleration of gravity. Strictly observe hints in chapter Adjustment.

6.7 Adjustment

As the acceleration value due to gravity is not the same at every location on earth, each balance must be coordinated - in compliance with the underlying physical weighing principle - to the existing acceleration due to gravity at its place of location (only if the balance has not already been adjusted to the location in the factory). This adjustment process must be carried out for the first commissioning, after each change of location as well as in case of fluctuating environment temperature. To receive accurate measuring values it is also recommended to adjust the balance periodically in weighing operation.

- i** The adjustment is locked for verified balances. Carrying out adjustment requires that the seal is destroyed and the adjusting switch is confirmed in step 3 when turning on the scale. For position of adjusting switch, see chpt. 6.8.1

Attention:

After destruction of the seal the balance must be re-verified by an authorised agency and a new verification wire/seal mark fitted before it can be reused for applications subject to verification.

Procedure when adjusting:

Observe stable environmental conditions. A warming up time (see chapter 1) is required for stabilization. Ensure that there are no objects on the weighing plate. Arrange adjustment weight, details see chap.1 „Technical data“

1. Switch-on balance and during the selftest press .

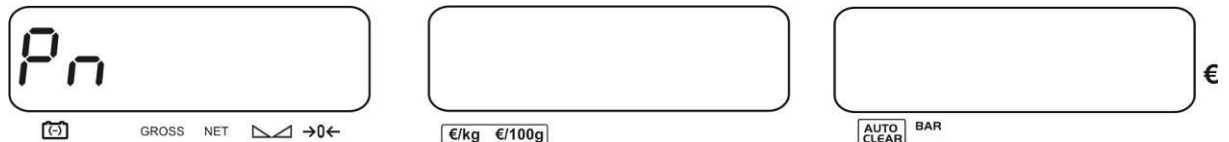

2. Use the numeric keys to enter „0000“ for a password and confirm by pressing .



3. The adjustment function „CAL F0“ is displayed. Press the adjusting switch and confirm by pressing .

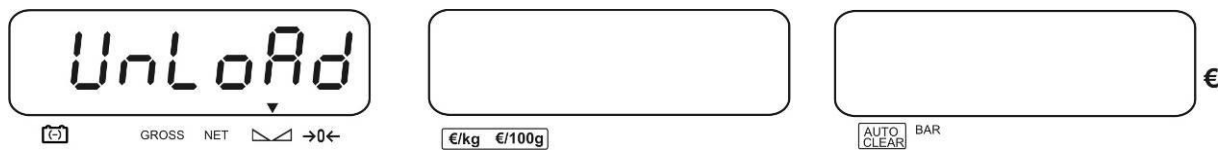

4. Ensure that there are no objects on the weighing plate. Wait for stability display, then press . The required adjustment weight is shown.



5. Place the adjustment weight carefully in the centre of the weighing pan, press  and the adjusting process will be started.

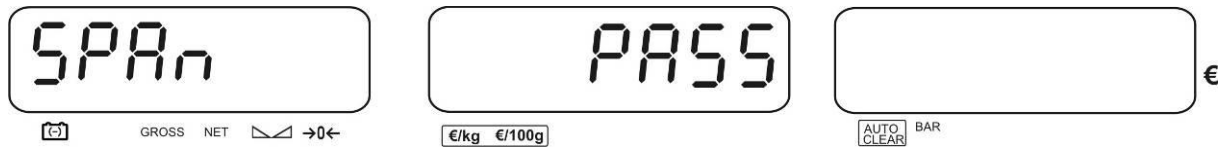
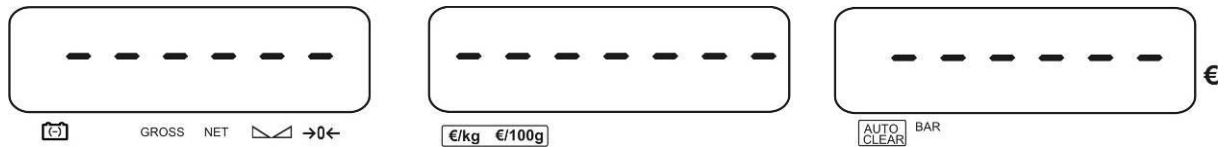

6. The adjustment process has been successfully completed. Take away adjustment weight.
7. Press  and the scales will return to weighing mode.

i In case of an adjustment error or incorrect adjusting weight the display will show an error message (*SPAn / FAi L*), repeat adjustment process.

6.8 Verification

General:

According to EU directive 90/384/EEC balances must be officially verified if they are used as follows (legally controlled area):

- a) For commercial transactions if the price of goods is determined by weighing.
- b) For the production of medicines in pharmacies as well as for analyses in the medical and pharmaceutical laboratory.
- c) For official purpose.
- d) For manufacturing final packages.

In cases of doubt, please contact your local trade in standard.

After verification the balance is sealed at the indicated positions.

Verification of the balance is invalid without the "seal".

Verification notes:

An EU type approval exists for balances described in their technical data as verifiable. If a balance is used where obligation to verify exists as described above, it must be verified and re-verified in regular intervals.

Re-verification of a balance is carried out according to the respective national regulations. The validity for verification of balances in Germany is e.g. 2 years.

The legal regulation of the country where the balance is used must be observed!

Balances with obligation to verify must be taken out of operation if:

- The **weighing result of the balance is outside the error limit**. Therefore, in regular intervals load balance with known test weight (ca. 1/3 of the max. load) and compare with displayed value.
- The **reverification deadline** has been exceeded.

6.8.1 Adjustment controls and seals

Possible seals: **B** enforced, and **A** or **C**

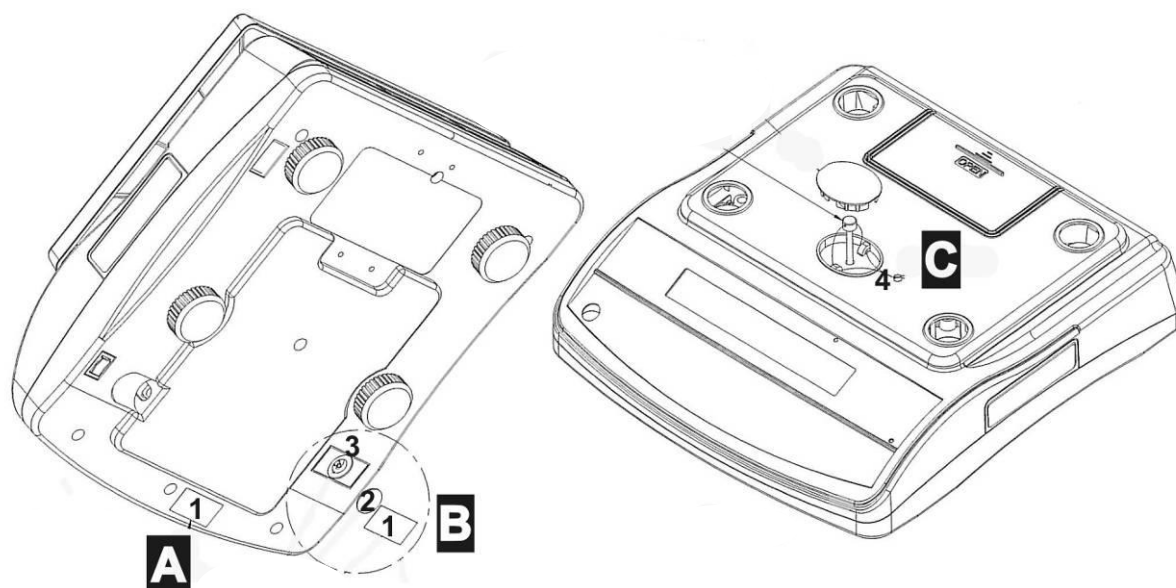

1. Seal mark 1
2. Cover
3. Verification switch
4. Verification wire

6.9 Checking the balance verification settings

For the adjustment, the balance must be switched over to service mode.



In the service mode the parameters of the balance can be modified. If this happened accidentally, please contact KERN.

In calibrated scales the service mode is locked individually for each switch. To disable the access lock, destroy the seal and confirm the switch. For position of switch see chpt. 6.8.1.

Attention:

After destruction of the seal the balance must be re-verified by an authorised agency and a new verification wire/seal mark fitted before it can be reused for applications subject to verification.

6.9.1 Service mode

This overview of the service parameters is merely for checking the parameters set by the appropriate Bureau of Standards. No changes may be made.

Access to menu:

1. Switch-on balance and during the selftest press .

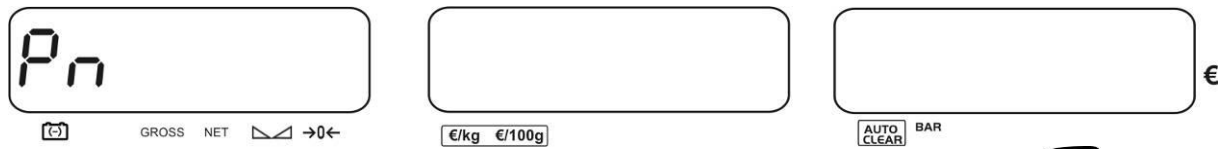

2. Use the numeric keys to enter „0000“ for a password and confirm by .

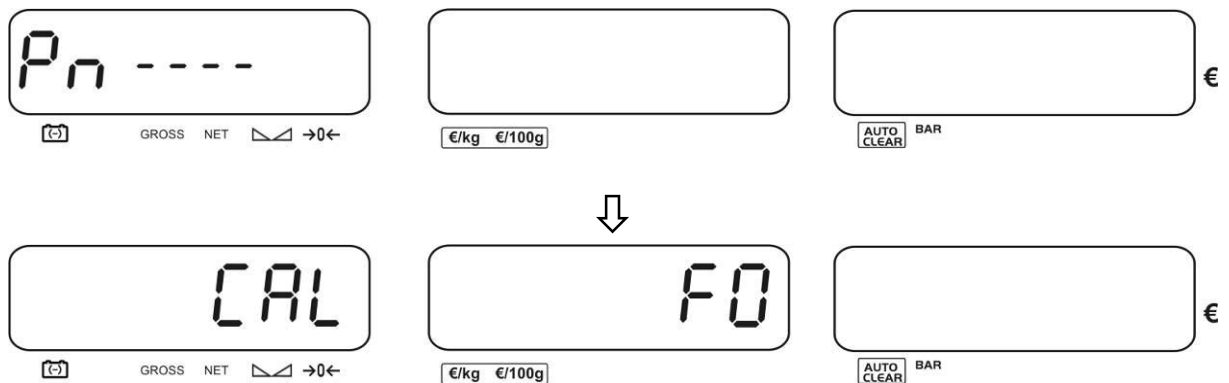





3. The first function „F0 CAL“ is displayed. Press adjusting switch.

Select function:

- ⇒ You can select individual functions containing the current settings one after the other by using  or a numeric key (i.e. for F0 or 2 for F2).

Change / save settings:

- ⇒ Confirm selected function by pressing . Select desired setting by pressing  and confirm by pressing  or cancel by pressing .

Exit menu:

- ⇒ Using  the balance returns into the weighing mode.

Overview for service parameter:

Factory settings are marked by [*].

Function		Settings			Description
CAL	F0				Adjustment function, see chpt. 6.7
CAL	F1				Resolution
		rES	1	3000	
		rES	1	6000	
		rES	dual	rAnge*	Always use this setting
CAL	F2				€ / kg ⇔ can be switched over to € / 100g
		Price	Unit	1*	Always use this setting
		Price	Unit	2	
CAL	F3				Weighing range (max)
		CAPA	6		Factory setting RPB 6K1DM, RPB 6K1DHM
		CAPA	15		Factory setting RPB 15K2DM, RPB 15K2DHM
		CAPA	30		Factory setting RPB 30K5DM, RPB 30K5DHM
CAL	F4				Position decimal point "weight display"
		0.000	Point		Factory setting RPB 6K1DM, RPB 6K1DHM, RPB 15K2DM, RPB 15K2DHM
		0.00	Point		Factory setting RPB 30K5DM, RPB 30K5DHM
		0.0	Point		
		0	Point		

CAL	F5					Position decimal point "price displays"
			Point	0	0	
				0.0	0.0	
				0.00	0.00*	Always use this setting
				0.000	0.000	
				0.0000	0.0000	
CAL	F6					Display internal resolution
			XXX	A-d	CoUntS	
CAL	F7	Coin				Interval size currency
			Min	Coin	1*	Always use this setting
			Min	Coin	2	
			Min	Coin	5	
			Min	Coin	10	
CAL	F8					Not documented
			rS-232	tYPE	PRINTER	
			rS-232	tYPE	oFF	Always use this setting
CAL	F9					Not documented
			bAUd	rAtE	2400	
			bAUd	rAtE	4800*	
			bAUd	rAtE	9600	
			bAUd	rAtE	19200	
CAL	F10					Not documented
			rS-232	mode	8 n 1*	
			rS-232	mode	7 E 1	
			rS-232	mode	7 o 1	
CAL	F11					Not documented
			PErCnt	tArE	on	
			PErCnt	tArE	off*	Always use this setting
CAL	F12					Not documented
			Grv	rAte	X.XXXX	

7 Operation Mode

7.1 Turn on/off



- ⇒ To turn on/off confirm forward at the underneath on the right of the scale and keep pressed for a little while. The balance will carry out a self-test. As soon as the weight display shows "0" in all the three display windows your balance is ready to weigh.





- ⇒ To switch-off push backward the switch-on/switch-out on the right lower side of the balance.

7.2 Zeroing

Resetting to zero corrects the influence of light soiling on the weighing plate.

- ⇒ Unload the balance
- ⇒ Press , the balance starts resetting to zero. The indicator [▼] above  appears.

7.3 Weighing with taring

- ⇒ Deposit weighing vessel. After successful stop check press the  button. Zero display and the indicator [▼] above [NET] appear.
- ⇒ Weigh the material, the net weight will be indicated.
- ⇒ The weight of the weighing container will be displayed as a minus number after removing the weighing container.
- ⇒ To delete the TARE value unload the weighing plate and press , the indicator [▼] above [GROSS] appears.

7.4 Overload warning

Overloading exceeding the stated maximum load (max) of the balance, minus a possibly existing tare load, must be strictly avoided. This could cause damage to the balance.

Exceeding maximum load is indicated by the display of „-OL-“, and an audio sound. Unload balance or reduce preload.

8 Weighing with price determination

As soon as the goods to be weighed are placed on the balance and the basic price has been set the price is calculated automatically and displayed in the provided field.

8.1 Basic price entry via keyboard

⇒ When using the weighing container, tare by using , see chpt. 7.3.

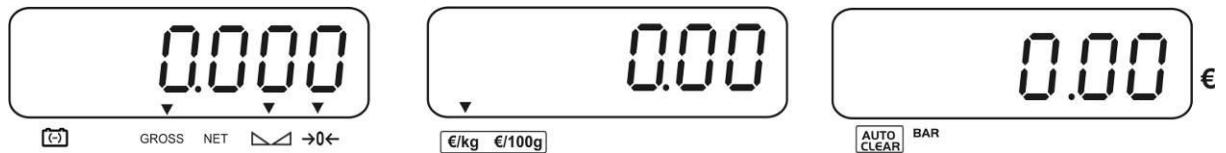

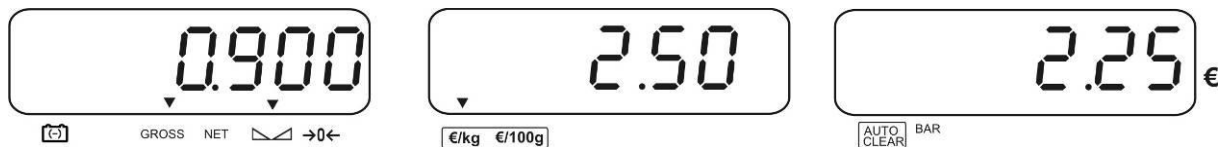

⇒ Place goods to be weighed on balance.

⇒ Enter basic price via numeric keys  ~  and the sales price will be automatically computed and displayed.



i

- The set basic price is deleted by .
- Using  switch over basic price from € / kg ↔ to € / 100g (see chapter 8.1.1).
- Calculating the change, see chap. 8.2

8.1.1 Unit switch over €/kg to €/100 g

The following parameters should be set for this:

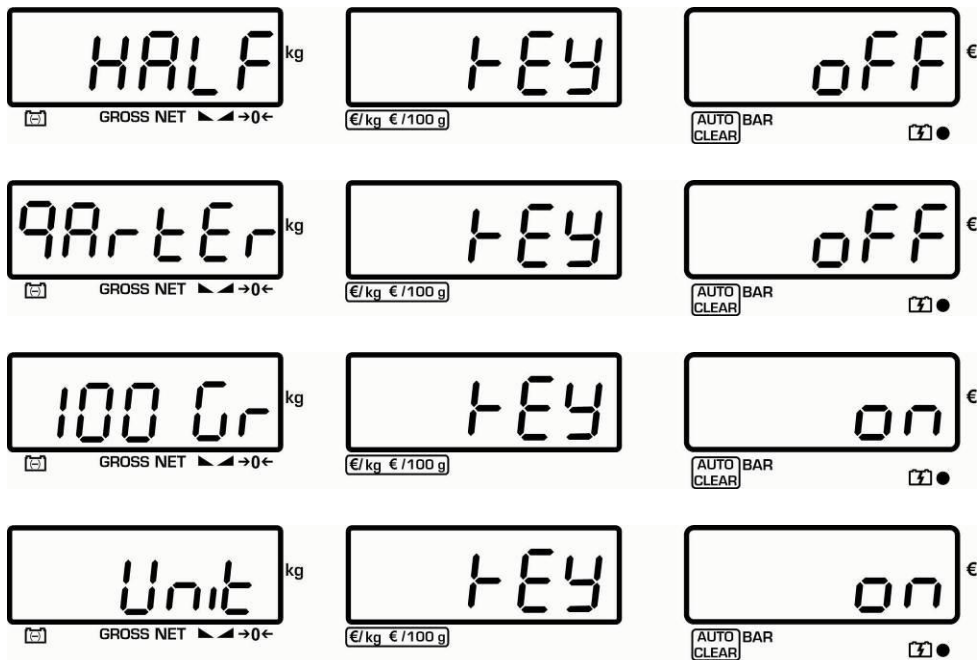

To carry out these settings please proceed as follows:

Switch-on balance and during the selftest press .

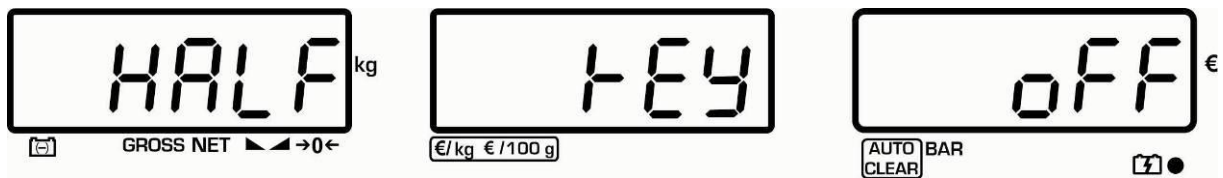

(should „OFF“ not be displayed, press )



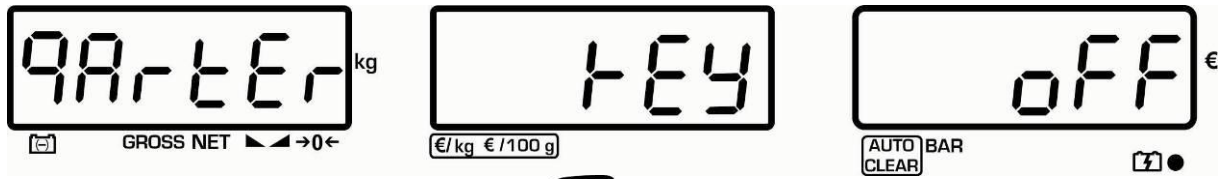

Press 

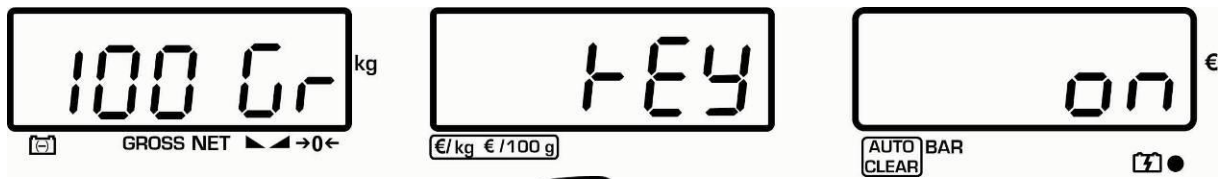

(should „off“ not be displayed, press )

Press 



(should „on“ not be displayed, press )

Press  again

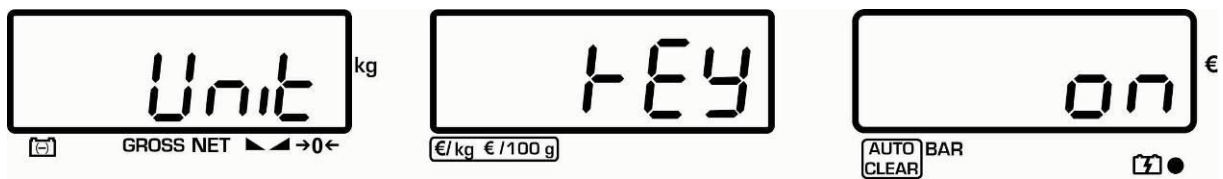

(should „on“ not be displayed, press )

Confirm by 

After a short acoustic signal the balance returns automatically into weighing mode.

The function is activated. Use  button to switch over between €/kg and €/100g.

8.2 Memory for basic price (PLU = Price look up)

The balance is able to store up to 10 basic prices.

Save:

⇒ Enter basic price via the numeric keys **0** ~ **9**.



⇒ Keep **PLU** pressed for about 3 seconds

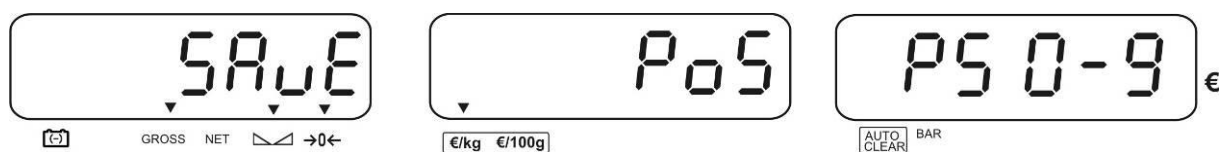

⇒ Enter the desired PLU key via the numeric keys **0** ~ **9**.

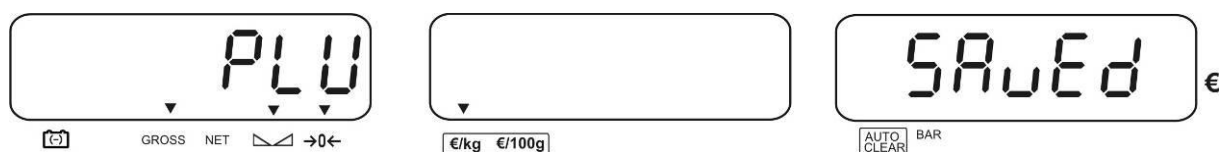

The basic price is saved at the entered PLU.

Retrieve / show sales price:

⇒ Place goods to be weighed

⇒ Press **PLU**

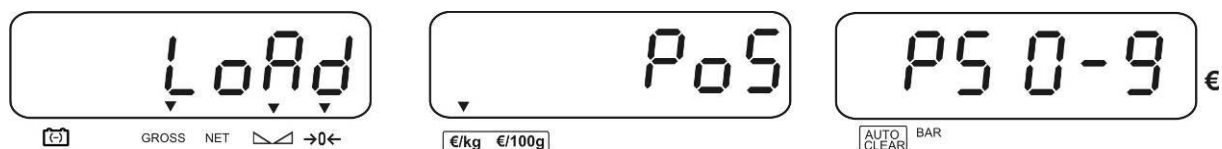

⇒ Press desired PLU **0** ~ **9** and the saved basic price as well as the sales prices computed from it will be shown.

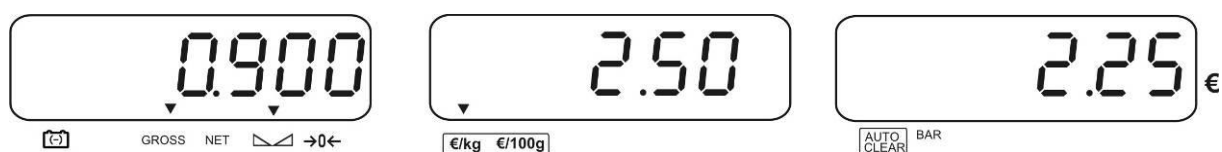

i Before calling-up an other PLU, the displayed basic price has to be deleted by **C**.

Calculating the change:

⇒ Press **BAR** at the display sales price (e.g. 2.25 €).

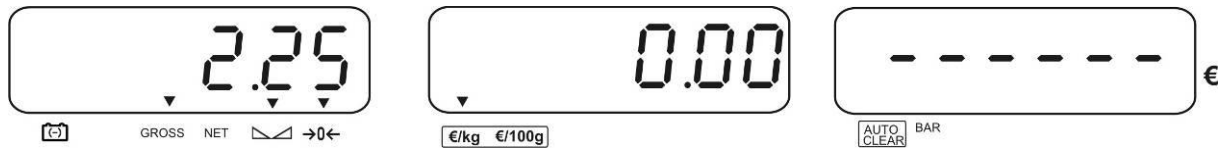

⇒ Enter the given amount of money, e.g. 5.00 € using the numeric keys **0** ~ **9**. The balance calculates the change and displays it, e.g. 2.75 €.

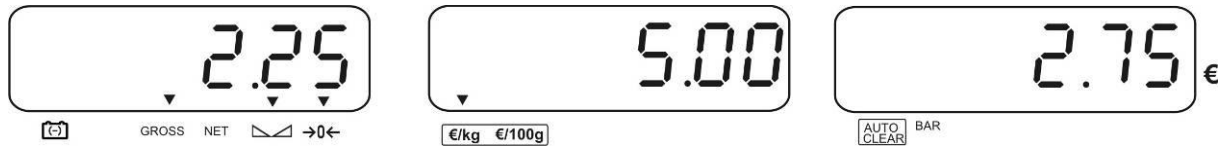

⇒ Using **→0←** or **TARE** the balance returns into the weighing mode.

9 Additional useful functions

9.1 AUTO CLEAR

Enable:

- ⇒ To enable the AUTO-CLEAR function press ; the arrow above „AUTO CLEAR“ will start flashing on the display at the same time.
The set basic price is deleted automatically when balance is unloaded.

Disable:

- ⇒ Press  anew, the AUTO-CLEAR function will be deactivated, the arrow above „AUTO CLEAR“ will extinguish.
When the load is removed, the set basic price will be retained.



9.2 Display background illumination

- ⇒ Press , „backlight“ with the current setting will appear.



- ⇒ Press  repeatedly until the desired setting is displayed.

- on** Background illumination on
- off** Background illumination off
- Auto** Automatic background illumination on when weighing plate is loaded

- ⇒ Either save by pressing  or cancel by pressing . The balance returns to weighing mode.

9.3 AUTO POWER OFF



To save the rechargeable battery (option), the automatic switch-off function can be activated, switch-off time selectable after 0, 3, 5 or 10 minutes.

⇒ Switch-on balance and during the selftest press . „Auto off“ with the current setting will appear.



⇒ Press  repeatedly until the desired setting is displayed.

- 0** Automatic switch off deactivated
- 3** Automatic switch off after 3 min
- 5** Automatic switch off after 5 min
- 10** Automatic switch off after 10 min

⇒ Either save by pressing  or cancel by pressing . The balance returns to weighing mode.

10 Service, maintenance, disposal

10.1 Cleaning

Before cleaning, please disconnect the appliance from the operating voltage.

Please do not use aggressive cleaning agents (solvents or similar agents), but a cloth dampened with mild soap suds. Ensure that no liquid penetrates into the device and wipe with a dry soft cloth.

Loose residue sample/powder can be removed carefully with a brush or manual vacuum cleaner.

Spilled weighing goods must be removed immediately.

10.2 Service, maintenance

The appliance may only be opened by trained service technicians who are authorized by KERN.

Before opening, disconnect from power supply.

10.3 Disposal

Disposal of packaging and appliance must be carried out by operator according to valid national or regional law of the location where the appliance is used.

11 Instant help

In case of an error in the program process, briefly turn off the balance and disconnect from power supply. The weighing process must then be restarted from the beginning.

Fault	Possible cause
The displayed weight does not glow.	<ul style="list-style-type: none">• The balance is not switched on.• The mains supply connection has been interrupted (mains cable not plugged in/faulty).• Power supply interrupted.• Batteries are inserted incorrectly or empty• No batteries inserted.
The displayed weight is permanently changing	<ul style="list-style-type: none">• Draught/air movement• Glass doors not closed• Table/floor vibrations• Weighing plate has contact with other objects.• Electromagnetic fields / static charging (choose different location/switch off interfering device if possible)
The weighing result is obviously incorrect	<ul style="list-style-type: none">• The display of the balance is not at zero• Adjustment is no longer correct.• The balance is on an uneven surface.• Great fluctuations in temperature.• Electromagnetic fields / static charging (choose different location/switch off interfering device if possible)

Should other error messages occur, switch balance off and then on again. If the error message remains inform manufacturer.

11.1 Error messages

ERR 4	Zero range exceeded
ERR 5	Invalid entry
ERR 6	Damaged electronics

12 Declaration of -Conformity



KERN & Sohn GmbH

D-72322 Balingen-Frommern

Postfach 4052

E-Mail: info@kern-sohn.de

Tel: 0049-[0]7433- 9933-0

Fax: 0049-[0]7433-9933-149

Internet: www.kern-sohn.de

Declaration of -Conformity

EG-Konformitätserklärung

EC- Déclaration de conformité

EC-Dichiarazione di conformità

EC- Declaração de conformidade

EC-Deklaracja zgodności

EC-Declaration of -Conformity

EC-Declaración de Conformidad

EC-Conformiteitverklaring

EC- Prohlášení o shode

EC-Заявление о соответствии

D	Konformitäts- erklärung	Wir erklären hiermit, dass das Produkt, auf das sich diese Erklärung bezieht, mit den nachstehenden Normen übereinstimmt.
GB	Declaration of conformity	We hereby declare that the product to which this declaration refers conforms with the following standards.
CZ	Prohlášení o shode	Tímto prohlašujeme, že výrobek, kterého se toto prohlášení týká, je v souladu s níže uvedenými normami.
E	Declaración de conformidad	Manifiestamos en la presente que el producto al que se refiere esta declaración está de acuerdo con las normas siguientes
F	Déclaration de conformité	Nous déclarons avec cela responsabilité que le produit, auquel se rapporte la présente déclaration, est conforme aux normes citées ci-après.
I	Dichiarazione di conformità	Dichiariamo con ciò che il prodotto al quale la presente dichiarazione si riferisce è conforme alle norme di seguito citate.
NL	Conformiteit- verklaring	Wij verklaren hiermede dat het product, waarop deze verklaring betrekking heeft, met de hierna vermelde normen overeenstemt.
P	Declaração de conformidade	Declaramos por meio da presente que o produto no qual se refere esta declaração, corresponde às normas seguintes.
PL	Deklaracja zgodności	Niniejszym oświadczamy, że produkt, którego niniejsze oświadczenie dotyczy, jest zgodny z poniższymi normami.
RUS	Заявление о соответствии	Мы заявляем, что продукт, к которому относится данная декларация, соответствует перечисленным ниже нормам.

Electronic Balance: KERN RPB-D

EU Directive	Standards
2004/108/EC	EN55022: 2006 A1:2007 EN61000-3-3:1955+A1:2001+A2:2005 EN55024: 1998+A1:2001+A2:2003
2006/95/EC	EN 60950-1:2006 EN 60065:2002+A1:2006

Datum 08.04.2013
Date

Ort der Ausstellung 72336 Balingen
Place of issue

Signatur
Signature

Albert Sauter
KERN & Sohn GmbH
Geschäftsführer
Managing director

KERN & Sohn GmbH, Ziegelei 1, D-72336 Balingen, Tel. +49-[0]7433/9933-0
Fax +49-[0]7433/9933-149, E-Mail: info@kern-sohn.com, Internet: www.kern-sohn.com