



KERN & Sohn GmbH

Ziegelei 1
D-72336 Balingen
email: info@kern-sohn.com

Phone: +49-[0]7433- 9933-0
Fax: +49-[0]7433-9933-149
Internet: www.kern-sohn.com

Návod na obsluhu(EN)

Nerezová plošinová váha pre mäsiarov KERN SFB

Version 2.4
12/2013
GB



SFB-BA-e-1324



KERN SFB

Version 2.4 12/2013

Operating instructions stainless steel scale

Table of Contents

1	Technical Data	4
2	Appliance overview	10
2.1	Keyboard overview	11
2.1.1	Numeric input via navigation keys	12
2.2	Overview of displays	12
3	Basic Information (General)	13
3.1	Proper use	13
3.2	Improper Use	13
3.3	Warranty	13
3.4	Monitoring of Test Resources	14
4	Basic Safety Precautions	14
4.1	Pay attention to the instructions in the Operation Manual	14
4.2	Personnel training	14
5	Transportation & Storage	14
5.1	Testing upon acceptance	14
5.2	Packaging / return transport	14
6	Unpacking and implantation	15
6.1	Installation Site, Location of Use	15
6.2	Unpacking/implantation	15
6.2.1	Tripod	17
6.3	Mains connection	20
6.4	Rechargeable battery operation	20
6.5	Protection type IP65	20
6.6	Adjustment	21
6.6.1	Verified models	22
6.6.2	Non verifiable models	24
6.7	Linearization	25
6.7.1	Verified models	25
6.7.2	Non-verified models	26
6.8	Verification	27

7	Operation	28
7.1	Start-up.....	28
7.2	Switching Off	28
7.3	Zeroing	28
7.4	Simple weighing.....	28
7.5	Switch-over weighing unit (only not verifiable models)	29
7.6	Weighing with tare	30
7.7	Weighing with tolerance range	30
7.7.1	Tolerance check for target weight.....	31
7.7.2	Tolerance check for target quantity.....	33
7.8	Manual totalizing.....	35
7.9	Automatic adding-up.....	37
7.10	Parts counting.....	38
7.11	Animal weighing.....	39
7.12	Lock keyboard	40
7.13	Display background illumination.....	40
7.14	Automatic switch-off function "AUTO OFF"	41
8	Menu	42
8.1	Overview non verifiable models	43
8.2	Overview verified models	45
9	Service, maintenance, disposal	48
9.1	Cleaning	48
9.2	Service, maintenance	48
9.3	Disposal.....	48
9.4	Error messages	49
10	Data output RS 232C (optional)	50
10.1	Technical Data.....	50
10.2	Technical data	50
10.3	Printer mode	50
10.4	Output log (continuous output).....	51
10.5	Remote control instructions	51
11	Instant help.....	52
12	Declaration of Conformity	53

1 Technical Data

KERN	SFB 10K1HIP	SFB 15K5HIPM	SFB 20K2HIP
Readability (d)	1 g	5 g	2 g
Weighing range (max)	10 kg	15 kg	20 kg
Minimum load (Min)	-	100 g	-
Verification value (e)	-	5 g	-
Verification class	-	III	-
Reproducibility	1 g	5 g	2 g
Linearity	± 1 g	± 5 g	± 2 g
Recommended adjustment weight, not added (class)	10 kg (M1)	15 kg (M1)	20 kg (M1)
Warm-up time	30 minutes	10 minutes	30 minutes
Stabilization time (typical)	2 sec.		
Weighing unit	kg		
Auto Off	Available options		
Ambient temperature	-10°C – 40°C		
Moist environment	0 % - 95 % (non-condensing)		
Electric Supply	Input voltage 110 V – 230 V AC		
	Power pack secondary voltage 12 V, 500 mA		
Rechargeable battery (Standard)	Service life background light on for 40 h		
	Service life background light off 80 h		
	Charge time 12 h		
Dimensions display unit (B x D x H) mm	266 x 165 x 96		
Weighing surface mm	300 x 240		
IP protection	IP 65 (Only during operation on battery power)		
Interface	RS 232 optional		
Tripod	✓		

KERN	SFB 30K10HIPM	SFB 50K5HIP	SFB 50K5LHIP	SFB 50K-3XL
Readability (d)	10 g	5 g	5 g	5 g
Weighing range (max)	30 kg	50 kg	50 kg	50 kg
Minimum load (Min)	200 g	-	-	-
Verification value (e)	10 g	-	-	-
Verification class	III	-	-	-
Reproducibility	10 g	5 g	5 g	5 g
Linearity	± 10 g	± 5 g	± 5 g	± 10 g
Recommended adjustment weight, not added (class)	30 kg (M1)	50 kg (M1)	50 kg (M1)	50 kg (M1)
Warm-up time	10 minutes	30 minutes	30 minutes	30 minutes
Stabilization time (typical)	2 sec.			
Weighing unit	kg			
Auto Off	Available options			
Ambient temperature	-10°C – 40°C			
Moist environment	0 % - 95 % (non-condensing)			
Electric Supply	Input voltage 110 V – 230 V AC			
	Power pack secondary voltage 12 V, 500 mA			
Rechargeable battery (Standard)	Service life background light on for 40 h			
	Service life background light off 80 h			
	Charge time 12 h			
Dimensions display unit (B x D x H) mm	266 x 165 x 96			
Weighing surface mm	300 x 240	300 x 240	400 x 300	500 x 400
IP protection	IP 65 (Only during operation on battery power)			
Interface optional	RS232			
Tripod	✓			

KERN	SFB 60K20HIPM	SFB 60K20LHIPM	SFB 60K-2XLM
Readability (d)	20 g	20 g	20 g
Weighing range (max)	60 kg	60 kg	60 kg
Minimum load (Min)	400 g	400 g	400 g
Verification value (e)	20 g	20 g	20 g
Verification class	III	III	III
Reproducibility	20 g	20 g	20 g
Linearity	± 20 g	± 20 g	± 20 g
Recommended adjustment weight, not added (class)	60 kg (M1)	60 kg (M1)	60 kg (M1)
Warm-up time	10 minutes	10 minutes	10 minutes
Stabilization time (typical)	2 sec.		
Weighing unit	kg		
Auto Off	Available options		
Ambient temperature	-10°C – 40°C		
Moist environment	0 % - 95 % (non-condensing)		
Electric Supply	Input voltage 110 V – 230 V, AC		
	Power pack secondary voltage 12 V, 500 mA		
Rechargeable battery (Standard)	Service life background light on for 40 h		
	Service life background light off 80 h		
	Charge time 8 h		
Dimensions display unit (B x D x H) mm	266 x 165 x 96		
Weighing surface mm	300 x 240	400 x 300	500 x 400
IP protection	IP 65 (Only during operation on battery power)		
Interface optional	RS232		
Tripod	✓	✓	optional

KERN	SFB 100K10HIP	SFB 100K-2L	SFB 100K-2HM	SFB 100K-2LM
Readability (d)	10 g	10 g	50 g	50 g
Weighing range (max)	100 kg	100 kg	150 kg	150 kg
Minimum load (Min)	-	-	1 kg	1 kg
Verification value (e)	-	-	50 g	50 g
Verification class	-	-	III	III
Reproducibility	10 g	10 g	50 g	50 g
Linearity	± 10 g	± 20 g	± 50 g	± 50 g
Recommended adjustment weight, not added (class)	100 kg (M1)	100 kg (M1)	120 kg (M1)	150 kg (M1)
Warm-up time	30 minutes	30 minutes	10 minutes	10 minutes
Stabilization time (typical)	2 sec.			
Weighing unit	kg			
Auto Off	Available options			
Ambient temperature	-10°C – 40°C			
Moist environment	0 % - 95 % (non-condensing)			
Electric Supply	Input voltage 110 V – 230 V, AC			
	Power pack secondary voltage 12 V, 500 mA			
Rechargeable battery (Standard)	Service life background light on for 40 h			
	Service life background light off 80 h			
	Charge time 12 h			
Dimensions display unit (B x D x H) mm	266 x 165 x 96			
Weighing surface mm	400 x 300	500 x 400	400 x 300	500 x 400
IP protection	IP 65 (Only during operation on battery power)			
Interface optional	RS232			
Tripod	✓	optional	optional	optional

KERN	SFB 100K-2XL	SFB 100K-2XLM	SFB 120K50HIPM
Readability (d)	10 g	50 g	50 g
Weighing range (max)	100 kg	150 kg	120 kg
Minimum load (Min)	-	1 kg	1 kg
Verification value (e)	-	50 g	50 g
Verification class	-	III	III
Reproducibility	10 g	50 g	50 g
Linearity	± 20 g	± 50 g	± 50 g
Recommended adjustment weight, not added (class)	100 kg (M1)	150 kg (M1)	120 kg (M1)
Warm-up time	30 minutes	10 minutes	10 minutes
Stabilization time (typical)	2 sec.		
Weighing unit	kg		
Auto Off	Available options		
Ambient temperature	-10°C – 40°C		
Moist environment	0 % - 95 % (non-condensing)		
Electric Supply	Input voltage 110 V – 230 V, AC		
	Power pack secondary voltage 12 V, 500 mA		
Rechargeable battery (Standard)	Service life background light on for 40 h		
	Service life background light off 80 h		
	Charge time 12 h		
Dimensions display unit (B x D x H) mm	266 x 165 x 96		
Weighing surface mm	650 x 500	400 x 300	
IP protection	IP 65 (Only during operation on battery power)		
Interface optional	RS232		
Tripod	optional	optional	✓









KERN	SFB 200K-2XL	SFB 300K-1LM
Readability (d)	20 g	100 g
Weighing range (max)	200 kg	300 kg
Minimum load (Min)	-	2 kg
Verification value (e)	-	100 g
Verification class	-	III
Reproducibility	20 g	100 g
Linearity	± 40 g	± 100 g
Recommended adjustment weight, not added (class)	200 kg (M1)	300 kg (M1)
Warm-up time	30 minutes	10 minutes
Stabilization time (typical)	2 sec.	
Weighing unit	kg	
Auto Off	Available options	
Ambient temperature	-10°C – 40°C	
Moist environment	0 % - 95 % (non-condensing)	
Electric Supply	Input voltage 110 V – 230 V, AC	
	Power pack secondary voltage 12 V, 500 mA	
Rechargeable battery (Standard)	Service life background light on for 40 h	
	Service life background light off 80 h	
	Charge time 12 h	
Dimensions display unit (B x D x H) mm	266 x 165 x 96	
Weighing surface mm	650 x 500	
IP protection	IP 65 (Only during operation on battery power)	
Interface optional	RS232	
Tripod	optional	

2 Appliance overview







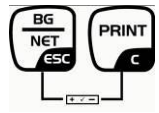
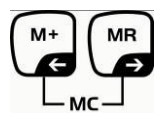

1. Battery status display
2. Keyboard
3. Weight display
4. Tolerance tag, see chap. 7.7
5. Weighing unit
6. Levelling screw
7. Spirit level (underneath weighing platform)

2.1 Keyboard overview

Button	Function
	⇒ Turn on/off
 Navigation key ←	<ul style="list-style-type: none"> • Zeroing • Confirm entry
 Navigation key ↑	⇒ Taring ⇒ At numeric input increase flashing digit ⇒ Scroll forward in menu
 Navigation key →	<ul style="list-style-type: none"> • Display sum total • Digit selection to the right
 Navigation key ←	<ul style="list-style-type: none"> • Add weighing value in summation memory • Digit selection to the left
 C	<ul style="list-style-type: none"> • Calculate weighing data via interface • Delete
 ESC	<ul style="list-style-type: none"> • Switch-over gross weight ⇔ net weight • Back to menu/weighing mode
	<ul style="list-style-type: none"> • Activate animal weighing function
	<ul style="list-style-type: none"> • Activate weighing with tolerance limits
 MC	<ul style="list-style-type: none"> • Delete total added memory

2.1.1 Numeric input via navigation keys

- ⇒ Press  current setting appears. The first digit is flashing and can be changed.
- ⇒ If the first digit is not to be changed, press  and the second digit will start flashing. Each time you press , the display unit jumps to the subsequent digit, returning to the first digit after the last digit has been pressed.
- ⇒ To change the selected (flashing) digit, press  repeatedly until the desired value appears. Then select by using additional digits and change these by using .
- ⇒ Finish entry with .

2.2 Overview of displays

Display	Significance
	Rechargeable battery very low
STABLE	Stability display
ZERO	Zero display
GROSS	Gross weight
NET	Net weight
AUTO	Automatic add-up enabled
Kg	Weighing unit
M+	Adding
LED + / ✓ / -	Indicators for weighing with tolerance limits

3 Basic Information (General)

3.1 Proper use

The balance you purchased is intended to determine the weighing value of material to be weighed. It is intended to be used as a “non-automatic balance”, i.e. the material to be weighed is manually and carefully placed in the centre of the weighing plate. As soon as a stable weighing value is reached the weighing value can be read.

3.2 Improper Use

Do not use balance for dynamic weighing. In the event that small quantities are removed or added to the material to be weighed, incorrect weighing results can be displayed due to the “stability compensation” in the balance. (Example: Slowly draining fluids from a container on the balance.)

Do not leave permanent load on the weighing plate. This may damage the measuring system.

Impacts and overloading exceeding the stated maximum load (max) of the weighing plate, minus a possibly existing tare load, must be strictly avoided. Balance may be damaged by this.

Never operate balance in explosive environment. The serial version is not explosion protected.

The structure of the balance may not be modified. This may lead to incorrect weighing results, safety-related faults and destruction of the balance.

The balance may only be used according to the described conditions. Other areas of use must be released by KERN in writing.

3.3 Warranty

Warranty claims shall be voided in case

- Our conditions in the operation manual are ignored
- The appliance is used outside the described uses
- The appliance is modified or opened
- Mechanical damage or damage by media, liquids, natural wear and tear
- The appliance is improperly set up or incorrectly electrically connected
- The measuring system is overloaded

3.4 Monitoring of Test Resources

In the framework of quality assurance the measuring-related properties of the balance and, if applicable, the testing weight, must be checked regularly. The responsible user must define a suitable interval as well as type and scope of this test. Information is available on KERN's home page (www.kern-sohn.com) with regard to the monitoring of balance test substances and the test weights required for this. In KERN's accredited DKD calibration laboratory test weights and balances may be calibrated (return to the national standard) fast and at moderate cost.

4 Basic Safety Precautions

4.1 Pay attention to the instructions in the Operation Manual

Carefully read this operation manual before setup and commissioning, even if you are already familiar with KERN balances.

4.2 Personnel training

The appliance may only be operated and maintained by trained personnel.

5 Transportation & Storage

5.1 Testing upon acceptance

When receiving the appliance, please check packaging immediately, and the appliance itself when unpacking for possible visible damage.

5.2 Packaging / return transport



- ⇒ Keep all parts of the original packaging for a possibly required return.
- ⇒ Only use original packaging for returning.
- ⇒ Prior to dispatch disconnect all cables and remove loose/mobile parts.
- ⇒ Reattach possibly supplied transport securing devices.
- ⇒ Secure all parts such as glass wind screen, weighing platform, power unit etc. against shifting and damage.

6 Unpacking and implantation

6.1 Installation Site, Location of Use

The balances are designed in a way that reliable weighing results are achieved in common conditions of use.

You will work accurately and fast, if you select the right location for your balance.

On the installation site observe the following:

- Place the balance on a firm, level surface;
- Avoid extreme heat as well as temperature fluctuation caused by installing next to a radiator or in the direct sunlight;
- Protect the balance against direct draughts due to open windows and doors;
- Avoid jarring during weighing;
- Protect the balance against high humidity, vapors and dust;
- Do not expose the balance to strong humidity for extended periods. Non-permitted condensation (condensation of air humidity on the appliance) may occur if a cold appliance is taken to a considerably warmer environment. In this case, acclimatize the disconnected appliance for ca. 2 hours at room temperature.
- Avoid static charge of goods to be weighed or weighing container.
- Being of protection type IP 67 as per DIN EN 60529, the weighing scale is suitable for short-term use in wet conditions.

Major display deviations (incorrect weighing results) may be experienced should electromagnetic fields (e.g. due to mobile phones or radio equipment), static electricity accumulations or instable power supply occur. Change location or remove source of interference.

6.2 Unpacking/implantation

Scope of delivery / serial accessories:

- Balance, see chap. 2
- Transit Securing
- Mains adapter
- Rechargeable battery
- Instruction Manual

Carefully remove the balance from the packaging, remove plastic cover, assemble the tripod and the display unit (see chap. 6.2.1) and setup balance at the intended workstation.

Remove the transportation lock:

1. Models platform size 300 x 240 mm

Remove the marked screws.

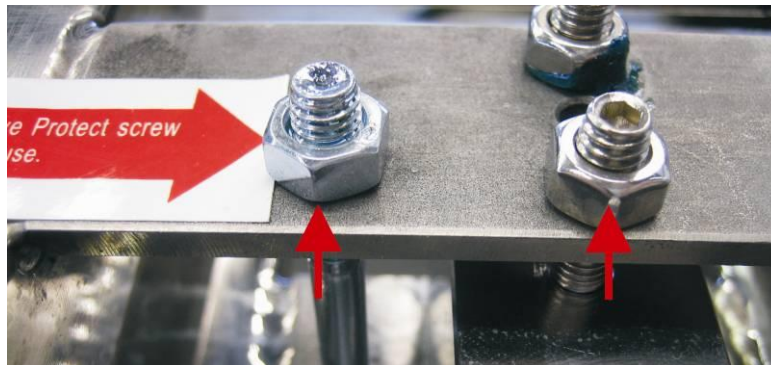

2. Models platform size 400 x 300 mm

Remove the screw marked by the label



Attention: The sealed screws must not be unscrewed.

Accurate weighing results require a weighing bridge with perfect horizontal alignment. During initial installation and after each change of work area it is necessary to level the weighing bridge.



- ⇒ As the air bubble is located under the weighing plate, remove it.
- ⇒ Level balance with foot screws until the air bubble of the water balance is in the prescribed circle.

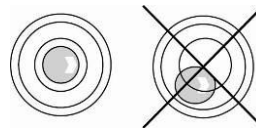

6.2.1 Tripod

Assemble example models platform size 300 x 240 mm:



Attach the tripod to the platform acc. to fig. using the 4 screws [1], securing disks and washers. Ensure that the cable is not damaged nor squeezed. Screw-in support screw [2] till it is safely fixed.



Remove display unit from holder, for that remove the turning knobs [3] on the side.



Attach the tripod with the four raised counter-sunk head screws [4] and the nuts on the holder of the display unit.

Re-attach and position display unit using the turning knobs [3].

Scope of delivery models platform size 400 x 300 mm:

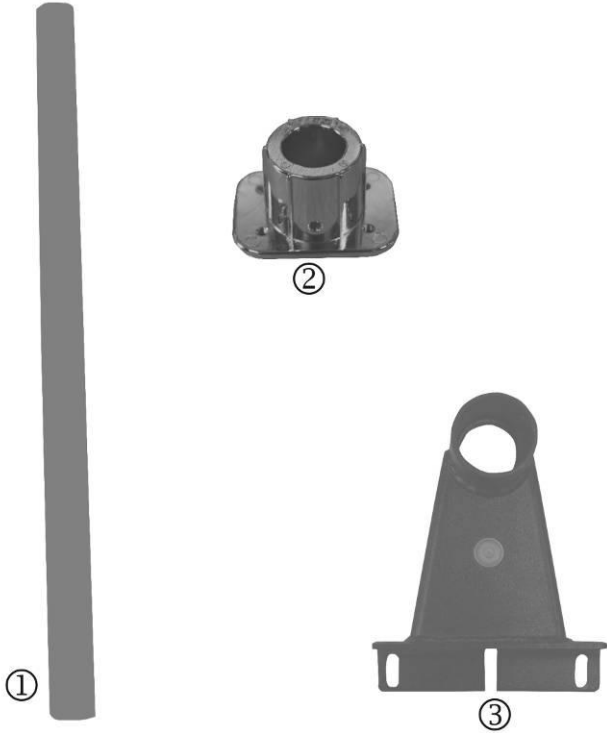

- ① Tripod tube
- ② Adapter display unit
- ③ Tripod foot

6.3 Mains connection

Power is supplied via the external mains adapter. The stated voltage value must be the same as the local voltage. Only use original KERN mains adapters. Using other makes requires consent by KERN.

6.4 Rechargeable battery operation

Before the first use, the battery should be charged by connecting it to the mains power supply for at least 12 hours.

The symbol appearing on the weight display  indicates that the battery is getting low. Approximately 10 h of instrument usage are left; afterwards it will shut off automatically. Use the supplied battery charger for charging the battery. Charge status of rechargeable battery is indicated by the LED display.

red: Voltage has dropped below prescribed minimum.

green: Rechargeable battery is completely charged

yellow: Charging storage battery

To save battery life, you can enable the automatic switch-off function "AUTO OFF", see chap. 7.14.

6.5 Protection type IP65

Designed for temporary contact with liquids. Use a damp cloth for cleaning. Dustproof.



IP65 protection is only ensured during operation on battery power.

6.6 Adjustment





















As the acceleration value due to gravity is not the same at every location on earth, each display unit with connected weighing plate must be coordinated - in compliance with the underlying physical weighing principle - to the existing acceleration due to gravity at its place of location (only if the weighing system has not already been adjusted to the location in the factory). This adjustment process must be carried out for the first commissioning, after each change of location as well as in case of fluctuating environment temperature. To receive accurate measuring values it is also recommended to adjust the display unit periodically in weighing operation.

i	<ul style="list-style-type: none">• In weighing systems with a resolution of $< 15\,000$ dividing steps an adjustment is recommended. In weighing systems with a resolution of $> 15\,000$ dividing steps a linearisation is recommended (see chap. 6.6).• Prepare the required adjustment weight. The weight to be used depends on the capacity of the scale. Carry out adjustment as near as possible to the scale's maximum weight. Info about test weights can be found on the Internet at: http://www.kern-sohn.com.• Observe stable environmental conditions. Stabilisation requires a certain warm-up time.
----------	---













6.6.1 Verified models

<p>i</p> <p>In verified weighing systems the menu item for adjustment „P2 mode“ is blocked.</p> <p>To override the blocked access you will have to destroy the seal before calling up the menu and to short-circuit the two contacts on the circuit board [K2], using a jumper (See chap.6.7).</p> <p>Attention: After destruction of the seal the weighing system must be re-verified by an authorised agency and a new verification wire/seal mark fitted before it can be reused for applications subject to verification.</p>	
--	--

Call up menu:











1. Switch-on balance and during the selftest press  .	
2. Press  ,  ,  subsequently, the first menu block „PO CHK“ will be displayed.	
3. Press  repeatedly until „P2 mode“ will be displayed.	
4. Press  and select the set weighing scales type by  .	 ⇕  ⇕ 
5. Acknowledge with  .	
6. Press  repeatedly until „CAL“ will be displayed.	
7. Confirm with  and select setting „noLin“ by  .	

How to carry out an adjustment:

<p>⇒ Confirm menu setting „noLin“ by . Ensure that there are no objects on the weighing plate.</p>	  
<p>⇒ Wait for stability display, then press .</p>	
<p>⇒ The currently set adjustment weight will be displayed.</p>	
<p>⇒ To change by using the navigation buttons (see chap. 2.1.1) select the desired setting, the active digit is flashing.</p> <p>⇒ Acknowledge with .</p>	
<p>⇒ Carefully place adjusting weight in the centre of the weighing plate. Wait for stability display, then press .</p>	
<p>⇒ After the adjustment the balance will carry out a self-test. Remove adjusting weight during selftest, balance will return into weighing mode automatically. An adjusting error or incorrect adjusting weight will be indicated by the error message; repeat adjustment procedure.</p>	

6.6.2 Non verifiable models

Call up menu:

1. Switch-on balance and during the selftest press .
 2. Press subsequently , ,  the first menu block „PO CHK“ will be displayed.
 3. Press  repeatedly until „P3 CAL“ will be displayed.
 4. Confirm with ; press  repeatedly until „CAL“ appears.
 5. Acknowledge using , the current setting is displayed.
- ⇒ Press  to confirm; press  to select setting.
 noLin = adjustment
 LineAr = linearization, see chap. 6.6

Pn

POCHK





P3CAL

CAL

noLin

↑
LineAr

How to carry out adjustment:

- ⇒ Confirm menu setting „noLin“ by .
 Ensure that there are no objects on the weighing plate.
- ⇒ Wait for stability display, then press .
- ⇒ The currently set adjustment weight will be displayed.
- ⇒ To change by using the navigation buttons (see chap. 2.1.1) select the desired setting, the active digit is flashing.
- ⇒ Acknowledge with .
- ⇒ Carefully place adjusting weight in the centre of the weighing plate. Wait for stability display, then press .
- ⇒ After the adjustment the balance will carry out a self-test. Remove adjusting weight **during** selftest, balance will return into weighing mode automatically. An adjusting error or incorrect adjusting weight will be indicated by the error message; repeat adjustment procedure.

noLin

↓
UnLd

STABLE
UnLd

30000 kg

STABLE
LoAd

PASS

STABLE
ZERO
GROSS
0.000 kg

6.7 Linearization

Linearity shows the greatest deviation of a weight display on the scale to the value of the respective test weight according to plus and minus over the entire weighing range. If linearity deviation is discovered during a testing instrument control, you can improve this by means of linearization.



- In balances with a resolution of > 15 000 dividing steps carrying out a linearisation is recommended.
- Carrying out linearization is restricted to specialist staff possessing well acquainted with the workings of weighing scales.
- The test weights to be used must be adapted to the weighing scale's specifications; see chapter "testing instruments control".
- Observe stable environmental conditions. Stabilisation requires a certain warm-up time.
- After successful linearisation you will have to carry out calibration; see chapter "testing instruments control".
- The adjustment is locked for verified balances. To disable the access lock, destroy the seal and actuate the adjustment switch. Position of the adjustment switch see chap. 6.7

6.7.1 Verified models

⇒ Menu item P2 mode ⇒ Cal ⇒ Call up liner, see chap. 6.5.1

⇒ Confirm by , the password query „Pn“ will be displayed.

⇒ Press subsequently , ,  or , , . Ensure that there are no objects on the weighing pan.

⇒ Wait for stability display, then press .

⇒ When "Ld 1" is displayed, put the first adjustment weight (1/3 max) carefully in the centre of the weighing platform. Wait for stability display, then press .

⇒ When "Ld 2" is displayed, put the second adjustment weight (2/3 max) carefully in the centre of the weighing platform. Wait for stability display, then press .

⇒ When "Ld 3" is displayed, put the third adjustment weight (max) carefully in the centre of the weighing platform. Wait for stability display, then press .

⇒ After linearisation the balance will carry out a self-test. Remove adjusting weight **during** selftest, balance will return into weighing mode automatically.

6.7.2 Non-verified models

⇒ Call-up menu item P3 CAL⇒Cal⇒Liner, see chap. 6.5.1



⇒ Confirm by , the password query „Pn“ will be displayed.



⇒ Press subsequently , ,  or , , . Ensure that there are no objects on the weighing pan.



⇒ Wait for stability display, then press .



⇒ When “Ld 1“ is displayed, put the first adjustment weight (1/3 max) carefully in the centre of the weighing platform. Wait



for stability display, then press .

⇒ When “Ld 2“ is displayed, put the second adjustment weight (2/3 max) carefully in the centre of the weighing platform.



Wait for stability display, then press .

⇒ When “Ld 3“ is displayed, put the third adjustment weight (max) carefully in the centre of the weighing platform. Wait



for stability display, then press .

⇒ After a successful linearisation the balance will carry out a self-test. Remove adjusting weight **during** selftest, balance will return into weighing mode automatically.



6.8 Verification

General introduction:

According to EU directive 90/384/EEC or 2009/23EG balances must be officially verified if they are used as follows (legally controlled area):

- For commercial transactions if the price of goods is determined by weighing.
- For the production of medicines in pharmacies as well as for analyses in the medical and pharmaceutical laboratory.
- For official purpose.
- For manufacturing final packages.

In cases of doubt, please contact your local trade in standard.

Verification notes:

An EU Qualification Approval is in existence for verified weighing systems. If a balance is used where obligation to verify exists as described above, it must be verified and re-verified at regular intervals.

Reverification is carried out according to the relevant national statutory regulations.

The validity for verification of balances in Germany is e.g. 2 years.

The legal regulation of the country where the balance is used must be observed!



Verification of the weighing system is invalid without the "seal".

Notes on verified models

Access to conductor plate:

- Remove seal
- Open display unit
- The application of the display unit as a weighing system able to be verified requires that the contacts of the circuit board are short-circuited with the help of a jumper [K1]. For non verifiable models remove the jumper.
- To adjust, short-circuit the contacts of the circuit board, using a jumper [K2].

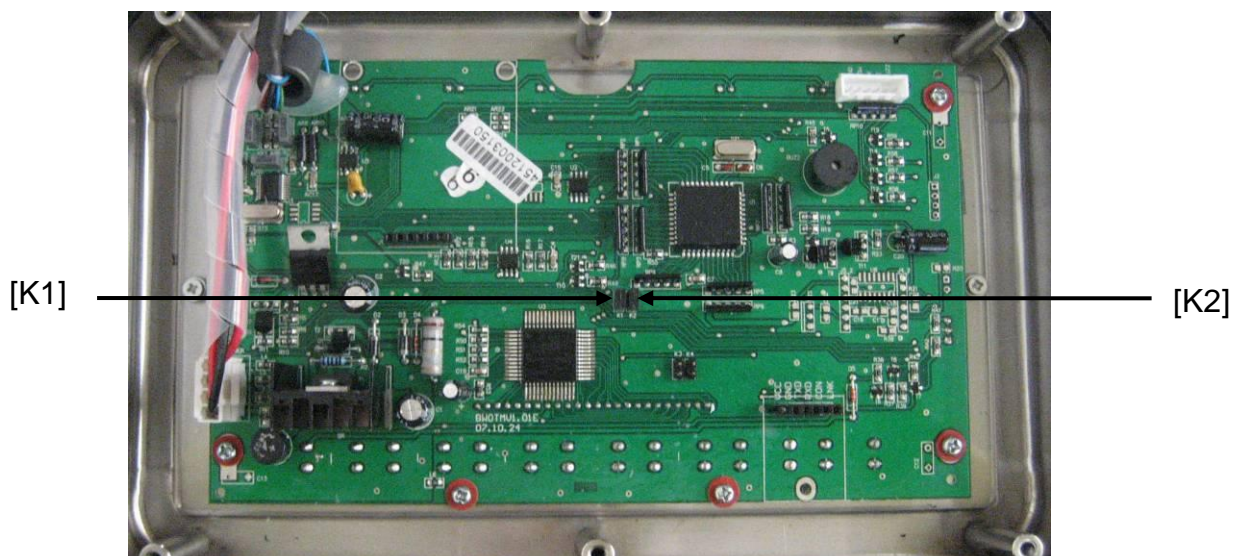

7 Operation

7.1 Start-up

- ⇒ Press , and the instrument will carry out a self-test. The instrument is ready for weighing when a weight display appears.



7.2 Switching Off

- ⇒ Press  until the display disappears.

7.3 Zeroing

Resetting to zero corrects the influence of light soiling on the weighing plate. Resetting range $\pm 2\%$ max. The instrument comprises an automatic zero setting function, however, the instrument can be reset to zero whenever needed as described below.

- ⇒ Remove load from weighing system
- ⇒ Press , and the zero display as well as the **ZERO** indicator will appear.



7.4 Simple weighing

- ⇒ Place goods to be weighed on balance.
- ⇒ Wait for stability display **STABLE**.
- ⇒ Read weighing result.



Overload warning

Overloading exceeding the stated maximum load (max) of the device, minus a possibly existing tare load, must be strictly avoided. The instrument may be damaged by overloading.

Exceeding of maximum load is indicated by “----“ as well as a signal sound. Remove load from weighing system or reduce preload.

7.5 Switch-over weighing unit (only not verifiable models)

How to enable weighing units:

⇒ Call-up menu item **P5 Unt**, see chap. 8

P5Unt

⇒ Press  and the first weighing unit with the current setting will be displayed.

on^{kg}

⇒ To enable [on] / disable [off] the displayed weighing unit, press .

⇕
off^{kg}

⇒ Acknowledge with . The next unit with the current setting will be displayed.

on^{lb}

⇒ To enable [off] / disable [on] the displayed weighing unit, press .

⇒ Acknowledge with .

⇒ Repeat sequence for each weighing unit.
Note: „tj“ and „Hj“ cannot be activated at the same time, only either ... or

⇒ Return to weighing mode using .

STABLE
ZERO
GROSS
0.000^{kg}

Switch-over weighing unit:

⇒ Keep  pressed, the display changes over to the weighing units activated before (e.g. kg ⇌ lb)

STABLE
GROSS
1.000^{kg}

⇕
STABLE
GROSS
2.205^{lb}

7.6 Weighing with tare

- ⇒ Deposit weighing vessel. After successful stop check press the  button. The zero display and the indicator **NET** appear.



The weight of the container is now internally saved.

- ⇒ Weigh the material, the net weight will be indicated.
- ⇒ The weight of the weighing container will be displayed as a minus number after removing the weighing container.
- ⇒ The tare procedure can be repeated as many times as necessary, for example with initial weighing of several components for a mix (add-on weighing). The limit is reached when the taring range (see type plate) capacity is full.

- ⇒ Switch between gross weight and net weight by pressing the  key.

- ⇒ To delete the tare value, remove load from weighing plate and press .

7.7 Weighing with tolerance range

You may determine an upper and lower limit for weighing with tolerance limits in order to ensure that the weighed load remains exactly within the fixed tolerance limits.

During tolerance checks such as dispensing, portioning and sorting, the instrument will indicate any lower deviation or exceeding of limits with the help of a visual signal or audio sound.

Acoustic signal:

The audio sound depends on the setting of the menu block "BEEP".

Options:

- no Acoustic signal turned off
- ok Acoustic signal sounds when load is within tolerance limits
- ng Acoustic signal sounds when load is beyond tolerance limits

Optical signal:

Three colour pilot lamps indicate whether load is within the two tolerance limits. The signal lamps provide the following information:

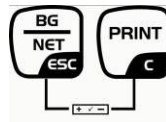

	+	Goods to be weighed above tolerance limit	Red signal lamp glowing
	✓	Goods to be weighed within tolerance range	Green signal lamp glowing
	-	Goods to be weighed below tolerance limit	Red signal lamp glowing

Settings for tolerance weighing may be set either by calling up menu block “**P0 CHK**” (See chap. 8) or by applying the faster option of pressing the key combination



7.7.1 Tolerance check for target weight

Settings

⇒ Press  and  at the same time in weighing mode.

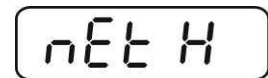

⇒ Press  until the display for entering the lower limit value nEt L appears.

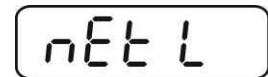

⇒ Press , the current setting will be displayed.



⇒ To enter the lower limit, e. g. 1000 Kg, press the navigation keys (See chap. 2.1.1); the currently enabled digit will be flashing.



⇒ Confirm input by .

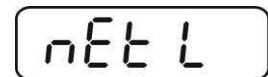

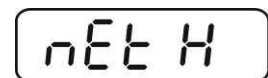

⇒ Press  repeatedly until nEt H is displayed.



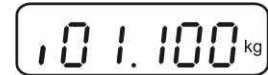

⇒ Press , the current setting for the upper limit will be displayed.

⇒ Press the navigation keys (See chap. 2.1.1) to enter the upper limit, e.g. 1,100 kg; the currently enabled digit will be flashing.

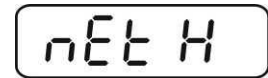

⇒ Confirm input by .



⇒ Press  repeatedly until bEEP is displayed.



⇒ Press  and the current setting for the acoustic signal will be shown.



⇒ Select desired setting (no, ok, ng) by .

⇒ Confirm input by .





⇒ Press , weighing system is in tolerance weighing mode. From here evaluation takes place whether the goods to be weighed are within the two tolerance limits.



Weighing with tolerance range

⇒ Tare when using a weighing container.

⇒ Put on goods to be weighed, tolerance control is started. The signal lights indicate whether the load is within the two set limits.













Load below specified tolerance	Load within specified tolerance	Load exceeds specified tolerance
		
Red signal light next to „-“ ON illuminated	Green signal light next to „✓“ illuminated	Red signal light next to „+“ ON illuminated

i

- The tolerance control is not active when the weight is under 20d.
- To delete limits, enter “00.000 kg“.

7.7.2 Tolerance check for target quantity

Settings

- ⇒ Press  and  at the same time in weighing mode.
- ⇒ Press  until the display for entering the lower limit value *PCS L* appears.
- ⇒ Press , the current setting will be displayed.
- ⇒ To enter the lower limit, e. g. 75 items, press the navigation buttons (see chap. 2.1.1); the currently enabled digit will be flashing.
- ⇒ Confirm input by .
- ⇒ Press  repeatedly until *PCS H* is displayed.
- ⇒ Press , the current setting for the upper limit will be displayed.
- ⇒ To enter the upper limit, e. g. 100 items, press the navigation buttons (see chap. 2.1.1); the currently enabled digit will be flashing.
- ⇒ Confirm input by .
- ⇒ Press  repeatedly until *bEEP* is displayed.
- ⇒  Press and the current setting for the acoustic signal will be shown.
- ⇒ Select desired setting (no, ok, ng) by .
- ⇒ Confirm input by .

STABLE
ZERO
GROSS
0.0000 kg



nEt H

PCS L

.00000 PCS

.00075 PCS

PCS L

PCS H

.00000 PCS

.00 100 PCS

PCS H

bEEP

ok



bEEP

⇒ Press ; weighing system is in tolerance weighing mode. From here evaluation takes place whether the goods to be weighed are within the two tolerance limits.



Weighing with tolerance range

- ⇒ Set item weight, see chap. 7.10.
- ⇒ Tare when using a weighing container.
- ⇒ Put on goods to be weighed, tolerance control is started. The signal lights indicate whether the load is within the two set limits.

Load below specified tolerance	Load within specified tolerance	Load exceeds specified tolerance
		
Red signal light next to „-“ ON illuminated	Green signal light next to „✓“, illuminated	Red signal light next to „+“ ON illuminated



- The tolerance control is not active when the weight is under 20d.
- To delete limits, enter „00000 PCS“.

7.8 Manual totalizing

With this function the individual weighing values are added into the summation memory by pressing  and edited, when an optional printer is connected.



- Menu settings:
„P1 COM“ or „P2 COM“ ⇨ „MODE“ ⇨ „PR2““, see chap. 8
- The totalisation function is not active when the weight is under 20d.

Add up:

⇒ Place goods to be weighed A.

Wait until the stability display **STABLE** appears, then press . The weight value will be saved and a printout received if an optional printer is connected.



⇒ Remove the weighed good. More weighed goods can only be added when the display = zero.



⇒ Place goods to be weighed B.

Wait until the stability display appears, then press . The weight value will be added to the summation memory and possibly printed. The number of weighing processes followed by the total weight will be shown for 2 sec.





⇒ Add more weighed goods as described before.



Please note that the weighing system must be unloaded between the individual weighing procedures.

⇒ This process may be repeated 99 times or till such time as the capacity of the weighing system has been exhausted.

Display and output sum „Total“:

⇒ Press  and the number of weighings followed by the total weight will be shown for 2 sec. To receive a printout, press  during this display.

Delete weighing data:

⇒ Press  and  at the same time. The data in the summation memory are deleted.



Printout example KERN YKB-01N, verified weighing system:

Menu setting „P1 COM“ or „P2 COM“ ⇒ „Lab 2“ / Prt 7“

Menu setting „P1 COM“ or „P2 COM“ ⇒ „Lab 0“ / Prt 0“

***** NO.: 1 GS: 2.000KG Total: 2.000KG *****	← 1
***** NO.: 2 GS: 2.000KG Total: 4.000KG *****	← 2
***** NO.: 3 GS: 3.000KG Total: 7.000KG *****	← 3
***** Total NO.: 3 Total: 7.000KG *****	← 4

***** GS: 2.000KG *****	← 1
***** GS: 2.000KG *****	← 2
***** GS: 3.000KG *****	← 3
***** Total *****	← 4
NO.: 3 Total: 7.000KG *****	

- 1 First weighing
- 2 Second weighing
- 3 Third weighing
- 4 Number of weighings / total

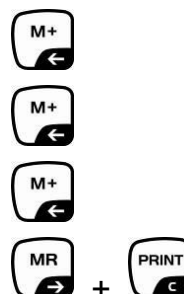

7.9 Automatic adding-up

With this function the individual weighing values are automatically added into the summation memory when the balance is unloaded without pressing  and edited, when an optional printer is connected.

i Menu settings:
„P1 COM“ or „P2 COM“ ⇒ „MODE“ ⇒ „AUTO“, see chap. 8
Indicator **AUTO** is displayed.



Add up:

- ⇒ Place goods to be weighed A.
After the standstill control sounds a signal tone. The weighing value is added to the summation memory, followed by printing.



- ⇒ Remove the weighed good. More weighed goods can only be added when the display = zero.
- ⇒ Place goods to be weighed B.
After the standstill control sounds a signal tone. The weighing value is added to the summation memory, followed by printing. The number of weighings, followed by the total weight, will be shown for 2 sec.



- ⇒ Add more weighed goods as described before.
Please note that the weighing system must be unloaded between the individual weighing procedures.
- ⇒ This process may be repeated 99 times or till such time as the capacity of the weighing system has been exhausted.

i Display and delete the weighing data, as well as printout examples see chap. 7.8.

7.10 Parts counting

Before the balance can count parts, it must know the average part weight (i.e. reference). Proceed by putting on a certain number of the parts to be counted. The balance determines the total weight and divides it by the number of parts, the so-called reference quantity. Counting is then carried out on the basis of the calculated average piece weight.

As a rule:

The higher the reference quantity the higher the counting exactness.

- ⇒ In weighing mode , press and hold until the message „P 10“ appears that is used to set the reference quantity.



STABLE ZERO
GROSS 0.0000 kg

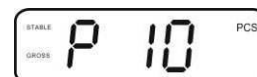

STABLE P 10 PCS
GROSS

- ⇒ Use  to set the desired reference quantity (such as 100), options include P 10, P 20, P 50, P100, P 200.

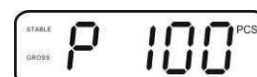

STABLE P 100 PCS
GROSS

- ⇒ Place as many items to be counted (such as 100 items) as demanded by the set reference quantity and confirm by



STABLE - - - - PCS
GROSS



-  The weighing scales calculate the reference weight. The current quantity (such as 100 items) will be displayed.

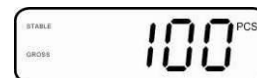

STABLE 100 PCS
GROSS

- ⇒ Remove reference weight. The balance is from now in parts counting mode counting all units on the weighing plate.



STABLE ZERO 0 PCS
GROSS

- ⇒ Back to Weighing mode by .



STABLE ZERO 0.0000 kg
GROSS

7.11 Animal weighing

The animal weighing function is ideal for unstable loads.

The weighing system calculates and displays a stable mean average from several weighing values.



The animal weighing program may either be enabled by calling up menu block "P3 OTH" or "P4 OTH" ⇒ „ANM“ ⇒ „ON“ (See chap. 8) or by using the faster option of a key combination.



The indicator shows **HOLD** as long as the animal weighing function remains enabled.



⇒ Place the load onto the weighing system and wait until it is fairly stable.

⇒ Press  and  at the same time, a signal sounds, meaning that the animal weighing function is enabled.

During the calculation of a mean average you can add or remove loads as the mean average will be continuously updated.

⇒ To disable the animal weighing function press  and  at the same time.

7.12 Lock keyboard

Go to menu item “P3 OTH” or “P4 OTH” ⇒ „LOCK“, see chap. 8, and enable/disable the keyboard interlock. The enabled function will be locked after 10 minutes of inactivity. “K-LCK” will be displayed as soon as a key is pressed.

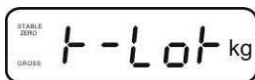

To cancel locking, keep pressed ,  and  at the same time (2s) until “U LCK” appears.

7.13 Display background illumination

⇒ Keep  pressed (3s) until “setbl” appears.



⇒ Press  again and the current setting will be displayed.

⇒ Use  to select desired setting.

bl on Background lighting is on continuously

bl off Background illumination off

bl Auto Automatic background illumination on when weighing plate is loaded

⇒ Save entry by  or cancel using .

7.14 Automatic switch-off function "AUTO OFF"

The instrument will switch off automatically after a set time when the display unit or weighing bridge has been idle.

⇒ Keep  pressed (3s) until "setbl" appears.

SEtbl

⇒ Call up **AUTO OFF** function using .

SEtoF

⇒ Press  - current setting appears.











⇒ Use  to select desired setting.

- of 0** **AUTO OFF** - function disabled
- of 3** Weighing system will be turned off after 3 min.
- of 5** Weighing system will be turned off after 5 min.
- of 15** Weighing system will be turned off after 15 min.
- of 30** Weighing system will be turned off after 30 min.



⇒ Save entry by  or cancel using .

8 Menu

Navigation in the menu:

<p>Call up menu</p>	<p>⇒ Switch-on balance and during the selftest press .</p> <p style="text-align: center;"></p> <p>⇒ Press , ,  subsequently, the first menu block „PO CHK“ will be displayed.</p> <p style="text-align: center;"></p>
<p>Select menu block</p>	<p>⇒ With help of , the individual menu items can be selected one after the other.</p>
<p>Select setting</p>	<p>⇒ Confirm selected menu item by pressing . The current setting will be displayed.</p>
<p>Change settings</p>	<p>⇒ To change to the available settings, press the navigations keys as described in chap. 2.1.</p>
<p>Acknowledge setting / exit the menu</p>	<p>⇒ Either save by pressing  or cancel by pressing .</p>
<p>Return to weighing mode</p>	<p>⇒ Press  repeatedly to exit menu.</p>

8.1 Overview non verifiable models

Menu block Main menu	Menu item Submenu	Available settings / explanation		
PO CHK Weighing with tolerance range, see chap. 7.7	SET H	Upper limit value „Tolerance check weighing“, input see chap. 7.7.1		
	SET LO	Lower limit value „Tolerance check weighing“, input see chap. 7.7.1		
	PCS H	Upper limit value „Tolerance check counting“, input see chap. 7.7.2		
	PCS L	Lower limit value „Tolerance check counting“, input see chap. 7.7.2		
	BEEP	no	Acoustic signal for weighing with tolerance range switched off	
		ok	Audio sound when load is within tolerance limits	
		nG	Audio sound when load is beyond tolerance limits	
P1 REF Zero point settings	A2n0	Automatic zero point correction (Autozero) by changing the display, digits selectable (0.5d, 1d, 2d, 4d)		
	0AUto	Zero setting range Load range where the display after switching-on the balance is set to zero. Selectable 0, 2, 5, 10, 20, 50, 100 %		
	0rAGE	Zero setting range Load range where the display is set to zero by pressing  . Selectable 0, 2, 4, 10, 20*, 50, 100%.		
	0tArE	Automatic taring „on / off“, taring range adjustable in menu item „0Auto“.		
	SPEEd	Not documented		
	Zero	Zero point setting		
	P2 COM Interface parameter	MODE	CONT	Continuous data output
ST1			One output for stable weighing value	
STC			Continuous data output of stable weighing values	
PR1			Output after pressing 	
PR2			Manual totalizing, see chap. 7.8. Press  and the weighing value will be added to the summation memory and issued.	
AUTO*			For automatic add-up see chap. 7.9. This function is used to issue and add individual weighing values automatically to the summation memory on unloading of weighing scale.	
ASK			For remote control commands, see chap. 10.4	
wirel kit 1			Not documented	
BAUD			Available Baudrate: 600, 1200, 2400, 4800, 9600*	

	Pr	7E1	7 bits, even parity	
		7o1	7 bits, odd parity	
		8n1*	8 bits, no parity	
	PTYPE	tPUP*	Standard printer setting	
		LP50	Not documented	
	Lab	Lab x (Lab 0*)	For data output format, see chap.8.2, tab. 1	
	Prt	Prt x (Prt 0*)		
LAnG	eng*	Standard settings English		
	chn			
P3 CAL Configuration data	COUNT	Display internal resolution		
	DECI	Position of the decimal dot		
	DUAL	Setting balance type, capacity (Max) and readability (d)		
		off	Single-range balance	
			R1 inc	Readability
			R1 cap	Capacity
		on	Dual range balance	
			R1 inc	Readability 1st weighing range
			R1 cap	Capacity 1st weighing range
			R2 inc	Readability 2nd weighing range
R2 cap	Capacity 2nd weighing range			
CAL	noLin	For adjustment, see chap. 6.5.2		
	Liner	For linearization, see chap. 6.6.2		
GrA	Not documented			
P4 OTH	LOCK	on	Keyboard lock enabled, see chap. 7.12	
		off*	Keyboard lock disabled	
	ANM	on	Animal weighing enabled, see chap. 7.11	
		off*	Animal weighing disabled	
P5 Unt Switch-over weighing unit, see chap. 7.5	kg	on*		
		off		
	g	on		
		off*		
	lb	on		
		off*		
	oz	on		
		off*		
	tJ	on		
		off		
	HJ	on		
		off		
P6 xcl		Not documented		
P7 rst		Use  to reset balance settings to factory default.		
P8 uwb		Not documented		

Factory settings are marked by *.



8.2 Overview verified models

In verified weighing systems the access to „P2 mode and „P4 tAr“ is locked.



In order to unlock the access, the seal must be destroyed and both contacts of the printed circuit board [K2] must be short-circuited by a jumper, see chap. 6.11.

Attention:

After destruction of the seal the weighing system must be re-verified by an authorised agency and a new verification wire/seal mark fitted before it can be reused for applications subject to verification.

Menu block Main menu	Menu item Submenu	Available settings / explanation		
PO CHK Weighing with tolerance range, see chap. 7.7	SET H	Upper limit value „Tolerance check weighing“, input see chap. 7.7.1		
	SET LO	Lower limit value „Tolerance check weighing“, input see chap. 7.7.1		
	PCS H	Upper limit value „Tolerance check counting“, input see chap. 7.7.2		
	PCS L	Lower limit value „Tolerance check counting“, input see chap. 7.7.2		
	BEEP	no	Acoustic signal for weighing with tolerance range switched off	
		ok	Audio sound when load is within tolerance limits	
ng		Audio sound when load is beyond tolerance limits		
P1 COM Interface parameter	MODE	CONT	Continuous data output	
		ST1	One output for stable weighing value	
		STC	Continuous data output of stable weighing values	
		PR1	Output after pressing 	
		PR2	Manual totalizing, see chap. 7.8 Press  and the weighing value will be added to the summation memory and issued.	
		AUTO	For automatic totalizing see chap. 7.9. This function is used to issue and add individual weighing values automatically to the summation memory on unloading of weighing scale.	
		ASK	For remote control commands, see chap. 10.4	
		wireless Kit 1	Not documented	
	baud	Available Baudrate: 600, 1200, 2400, 4800, 9600		
	Pr	7E1	7 bits, even parity	
		7o1	7 bits, odd parity	
		8n1	8 bits, no parity	
	PtYPE	tPUP	Standard printer setting	
		LP50	Not documented	
	Lab	Lab x	Details see following table 1	
Prt	Prt x			

P2 mode Konfigurations- daten	SiGr	Single-range balance		
		COUNT	Display internal resolution	
		DECI	Position of the decimal dot	
		Div.	Readability [d] / verification value[s]	
		CAP	Balance capacity [Max]	
		CAL	noLin	Adjustment, see chap. 6.5
			LinEr	Linearisation, see chap. 6.7
		GrA	Not documented	
	dUAL 1	Dual range balance		
		Balance with two weighing ranges and different maximum load and weighing ranges and interval sizes but only one load-supporting pan, whereby each range extends from zero to the respective maximum capacity. When load is removed, weighing scales will remain in 2nd range.		
		COUNT	Display internal resolution	
		DECI	Position of the decimal dot	
		div.	div 1	Readability [d] / verification value [e] 1. weighing range
			div 2	Readability [d] / verification value [e] 2. weighing range
		CAP	CAP 1	Weighing scale capacity [max] 1. Weighing range
			CAP 2	Weighing scale capacity [max] 2. Weighing range
		CAL	noLin	Adjustment, see chap. 6.5.1
			LinEr	For linearization, see chap. 6.6.1
	GrA	Not documented		
	dUAL 2	Multi-interval balance		
Weighing scales with one weighing range subdivided into partial weighing ranges, each providing a different scale interval. The scale interval depends on the applied load and is automatically changed during loading and unloading.				
COUNT		Display internal resolution		
DECI		Position of the decimal dot		
div.		div 1	Readability [d] / verification value [e] 1. weighing range	
		div 2	Readability [d] / verification value [e] 2. weighing range	
CAP		CAP 1	Weighing scale capacity [max] 1. Weighing range	
		CAP 2	Weighing scale capacity [max] 2. Weighing range	
CAL		noLin	Adjustment, see chap. 6.5.1	
		LinEr	Linearisation, see chap. 6.6.1	
GrA	Not documented			
P3 OTH s. Kap. 7.11 / 7.12	LOCK	on	Keyboard lock enabled	
		off	Keyboard lock disabled	
	ANM	on	Animal weighing enabled	
		off	Animal weighing disabled	

P4 tAr Restricted taring range		Press  , the current setting will be displayed. Using the navigation buttons (see chap. 2.1.1) select the desired setting, the active digit is flashing. Confirm input by  .
P5 St Follow up tare	St on	Follow up tare switched on
	St off	Follow up tare switched off
P6 SP	7.5, 15, 30	Not documented

Tab. 1. Printout examples Standard printer

Lab Prt	0	1	2	3
0~3	***** GS: 5.000kg *****	***** NT: 5.000kg TW: 5.000kg GW: 10.000kg *****	***** GS: 5.000kg TOTAL: 10.000kg *****	***** NT: 5.000kg TW: 5.000kg GW: 10.000kg TOTAL: 10.000kg *****
4~7	***** No.: 1 GS: 5.000kg *****	***** No.: 1 NT: 5.000kg TW: 5.000kg GW: 10.000kg *****	***** No.: 1 GS: 5.000kg TOTAL: 10.000kg *****	***** No.: 1 NT: 5.000kg TW: 5.000kg GW: 10.000kg TOTAL: 10.000kg *****

GS / GW	Gross weight	NO	Number weighing processes
NT	Net weight	TOTAL	Total of all individual weighings
TW	Tare weight		

9 Service, maintenance, disposal

9.1 Cleaning

- Before cleaning, disconnect the appliance from the operating voltage.
- Cleaning is possible by water jet and short-time immersion.
- Do not apply aggressive detergents (solvents etc.).

9.2 Service, maintenance

The appliance may only be opened by trained service technicians who are authorized by KERN.

Before opening, disconnect from power supply.

9.3 Disposal

Disposal of packaging and appliance must be carried out by operator according to valid national or regional law of the location where the appliance is used.

9.4 Error messages

Error message	Description	Possible causes
----- -- ol --	Maximum load exceeded	<ul style="list-style-type: none"> • Unload weighing system or reduce preload.
Err 1	Incorrect data input	<ul style="list-style-type: none"> • Follow format “yy:mm:dd“
Err 2	Incorrect time entry	<ul style="list-style-type: none"> • Follow format “hh:mm:ss“
Err 4	Zeroing range exceeded due to switching-on balance or pressing  (normally 4% max)	<ul style="list-style-type: none"> • Object on the weighing plate • Overload when zeroing
Err 5	Keyboard error	
Err 6	Value outside the A/D changer range	<ul style="list-style-type: none"> • Weighing plate not installed • Damaged weighing cell • Damaged electronics
Err 9	Stability display does not appear	<ul style="list-style-type: none"> • Check the environmental conditions.
Err 10	Communication error	<ul style="list-style-type: none"> • No data
Err 15	Gravitation error	<ul style="list-style-type: none"> • Range 0.9 ~ 1.0
Err 17	Taring range exceeded	<ul style="list-style-type: none"> • Reduce load
Fai I h / Fai I l	Adjustment error	<ul style="list-style-type: none"> • Repeat adjustment.
Err P	Printer error	<ul style="list-style-type: none"> • Check communication parameters
Ba lo / Lo ba	Battery very low	<ul style="list-style-type: none"> • Recharge battery

Should other error messages occur, switch balance off and then on again. If the error message remains inform manufacturer.

10 Data output RS 232C (optional)

Weighing data can be issued according to menu settings either via the RS 232C interface or by pressing  via the interface.

This data exchange is asynchronous using ASCII - Code.

The following conditions must be met to provide successful communication between the weighing balance and the printer.

- Use a suitable cable to connect the weighing balance to the interface of the printer. Faultless operation requires an adequate KERN interface cable.
- Communication parameters (baud rate, bits and parity) of balance and printer must match. For detailed description of interface parameters see chap. 8, menu block „P1 COM“ or „P2 COM“.

10.1 Technical Data

10.2 Technical data

Connection 9 pin d-subminiature bushing

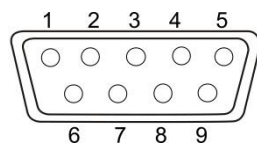

Pin 2 input

Pin 3 output

Pin 5 signal earth

Baud rate Optional 600/1200/2400/4800/9600

Parity 8 bits, no parity / 7 bits, even parity / 7 bits, odd parity

10.3 Printer mode

Printout examples (KERN YKB-01N):

- Weighing

ST, GS	1.000kg
--------	---------

Symbols:

ST	Stable value
US	Instable value
GS / GW	Gross weight
NT	Net weight
TW	Tare weight
NO	Number weighing processes
TOTAL	Total of all individual weighings
<lf>	Space line
<lf>	Space line

- Counting

PCS	100

10.4 Output log (continuous output)

- Weighing

		,			-/□							k	g	CR	LF
HEADER 1		HEADER 2		WEIGHT DATA							WEIGHT UNIT		TERMINATOR		

HEADER1: ST=STABLE , US=UNSTABLE

HEADER2: NT=NET , GS=GROSS

10.5 Remote control instructions

Command	Function	Printout examples
S	Stable weighing value for the weight is sent via the RS232 interface	ST,GS 1.000KG
W	Weighing value for the weight (stable or unstable) is sent via the RS232 interface	US,GS 1.342KG ST,GS 1.000KG
T	No data are sent, the balance carries out the tare function.	-
Z	No data are sent, the zero-display appears.	-
P	Quantity will be sent via the RS232-interface	10PCS

11 Instant help

In case of an error in the program process, briefly turn off the balance and disconnect from power supply. The weighing process must then be restarted from the beginning.

Help:

Fault

Possible cause

The displayed weight does not glow.

- The balance is not switched on.
- Mains power failure (mains cable defective).
- Power supply interrupted.
- (Rechargeable) batteries are inserted incorrectly or empty
- No (rechargeable) batteries inserted.

The displayed weight is permanently changing

- Draught/air movement
- Table/floor vibrations
- Weighing plate has contact with other objects.
- Electromagnetic fields / static charging (choose different location/switch off interfering device if possible)

The weighing result is obviously incorrect

- The display of the balance is not at zero
- Adjustment is no longer correct.
- Great fluctuations in temperature.
- Warm-up time was ignored.
- Electromagnetic fields / static charging (choose different location/switch off interfering device if possible)

Should other error messages occur, switch balance off and then on again. If the error message remains inform manufacturer.

12 Declaration of Conformity



KERN & Sohn GmbH
 D-72322 Balingen-Frommern
 Postbox 4052
 E-Mail: info@kern-sohn.de

Phone: 0049-[0]7433- 9933-0
 Fax: 0049-[0]7433-9933-149
 Internet: www.kern-sohn.de

Declaration of conformity

EC Declaration of Conformity
 EC- Déclaration de conformité
 EC-Dichiarazione di conformità
 EC- Declaração de conformidade
 EC-Deklaracja zgodności

EC-Declaration of -Conformity
 EC-Declaración de Conformidad
 EC-Conformiteitverklaring
 EC- Prohlášení o shode
 EC-Заявление о соответствии

D	Konformitäts- erklärung	Wir erklären hiermit, dass das Produkt, auf das sich diese Erklärung bezieht, mit den nachstehenden Normen übereinstimmt.
EN	Declaration of conformity	We hereby declare that the product to which this declaration refers conforms to the following standards.
CZ	Prohlášení o shode	Tímto prohlašujeme, že výrobek, kterého se toto prohlášení týká, je v souladu s níže uvedenými normami.
E	Declaración de conformidad	Manifestamos en la presente que el producto al que se refiere esta declaración está de acuerdo con las normas siguientes
F	Déclaration de conformité	Nous déclarons avec cela responsabilité que le produit, auquel se rapporte la présente déclaration, est conforme aux normes citées ci-après.
I	Dichiarazione di conformità	Dichiariamo con ciò che il prodotto al quale la presente dichiarazione si riferisce è conforme alle norme di seguito citate.
NL	Conformiteit- verklaring	Wij verklaren hiermede dat het product, waarop deze verklaring betrekking heeft, met de hierna vermelde normen overeenstemt.
P	Declaração de conformidade	Declaramos por meio da presente que o produto no qual se refere esta declaração, corresponde às normas seguintes.
PL	Deklaracja zgodności	Niniejszym oświadczamy, że produkt, którego niniejsze oświadczenie dotyczy, jest zgodny z poniższymi normami.
RUS	Заявление о соответствии	Мы заявляем, что продукт, к которому относится данная декларация, соответствует перечисленным ниже нормам.

Electronic Balance:

KERN KFB-TM, KFN-TM, BFB, BFN, IFB, NFB, SFB, UFA, UFB, UFN

EU Directive	Standards
2004/108/EC	EN55022: 2006 A1:2007 EN61000-3-3:1995+A1:2001+A2:2005 EN55024: 1998+A1:2001+A2:2003
2006/95/EC	EN 60950-1:2006 EN 60065:2002+A1:2006

Datum 08.04.2013
Date

Signatur
Signature

Ort der Ausstellung 72336 Balingen
Place of issue

Albert Sauter
 KERN & Sohn GmbH
Geschäftsführer
Managing director

KERN & Sohn GmbH, Ziegelei 1, D-72336 Balingen, Tel. +49-[0]7433/9933-0
 Fax +49-[0]7433/9933-149, E-Mail: info@kern-sohn.com, Internet: www.kern-sohn.com